

# POOL BREAKDOWN

## ROYAL SANDS ~ PS 27' ROUND 52''

RESIN TOP RAIL - RESIN VERTICAL

√	QTY	CARTON NUMBER	CARTON DESCRIPTION
	1	5-9927-835	ASSEMBLY PACK CARTON
	1	5-9818-835	TOP RAIL PACK CARTON
	1	5-9718-913	VERTICAL PACK CARTON
	1	5-0595-027	SIDEWALL CARTON
	1	5-9999-318	TOP CONNECTOR CARTON
	1	5-9118-835	SKIRT PACK CARTON



# CARTON BREAKDOWN

✓	ITEM	QTY	PART NUMBER	DESCRIPTION
<b>ASSEMBLY PACK # 5-9927-835</b>				
	1	12	583-1069	Stabilizer Rail (Large)
	2	12	583-1068	Stabilizer Rail (Small)
	3	18	580-2407	Bottom connector
	4	18	580-2408	Vertical end cap
	5	45	545-1001	Plastic coping
	6	18	589-1300	Bottom rail
	11	180	330-1127	Sheet metal screw, #10 x 1/2"
	12	18	580-2397	Vertical tab
	13	18	330-1075	Pan head screw #14 x 1/2"
	—	1	573-4100	Pool Parts List
	—	1	573-4047	Installation Instructions
	—	1	— — —	Warranty Card
	—	1	573-3169	"Safety First" Booklet

<b>TOP RAIL PACK # 5-9818-835</b>				
	14	18	587-1855	Top Rail

<b>VERTICAL PACK # 5-9718-913</b>				
	15	18	341-1525	Vertical

<b>TOP CONNECTOR PACK # 5-9999-318</b>				
	16	18	340-2799	Top Connector

<b>SKIRT PACK # 5-9118-835</b>				
	17	18	340-2800	Skirt
	18	18	510-1001	#10 x 1-1/2" Slotted Pan head screw

<b>SIDEWALL CARTON # 5-0595-027</b>				
	29	1	5-0595-027	Sidewall
	30	1	535-1442	Protective Strip
	31	26	321-1029	1/4-20 Hex Flange Locknut
	32	26	330-1280	1/4-20 x 1/2" Grade 5 Bolt
	—	1	560-1055	Warning Sign
	—	1	573-3169	"Safety First" Booklet
	—	1	573-3498	Safety DVD

# EXPLODED PARTS VIEW

REMOVE PRIOR TO INSTALLATION  
ONLY USE ON SIDE SUPPORTS FOR  
OVAL POOLS

REMOVE PRIOR TO  
INSTALLATION.  
USE PLUG TO COVER  
SCREW HOLE AFTER  
INSTALLATION.

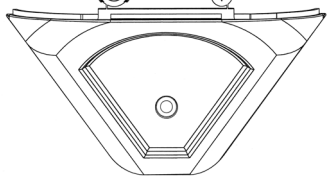

FRONT VIEW - SKIRT

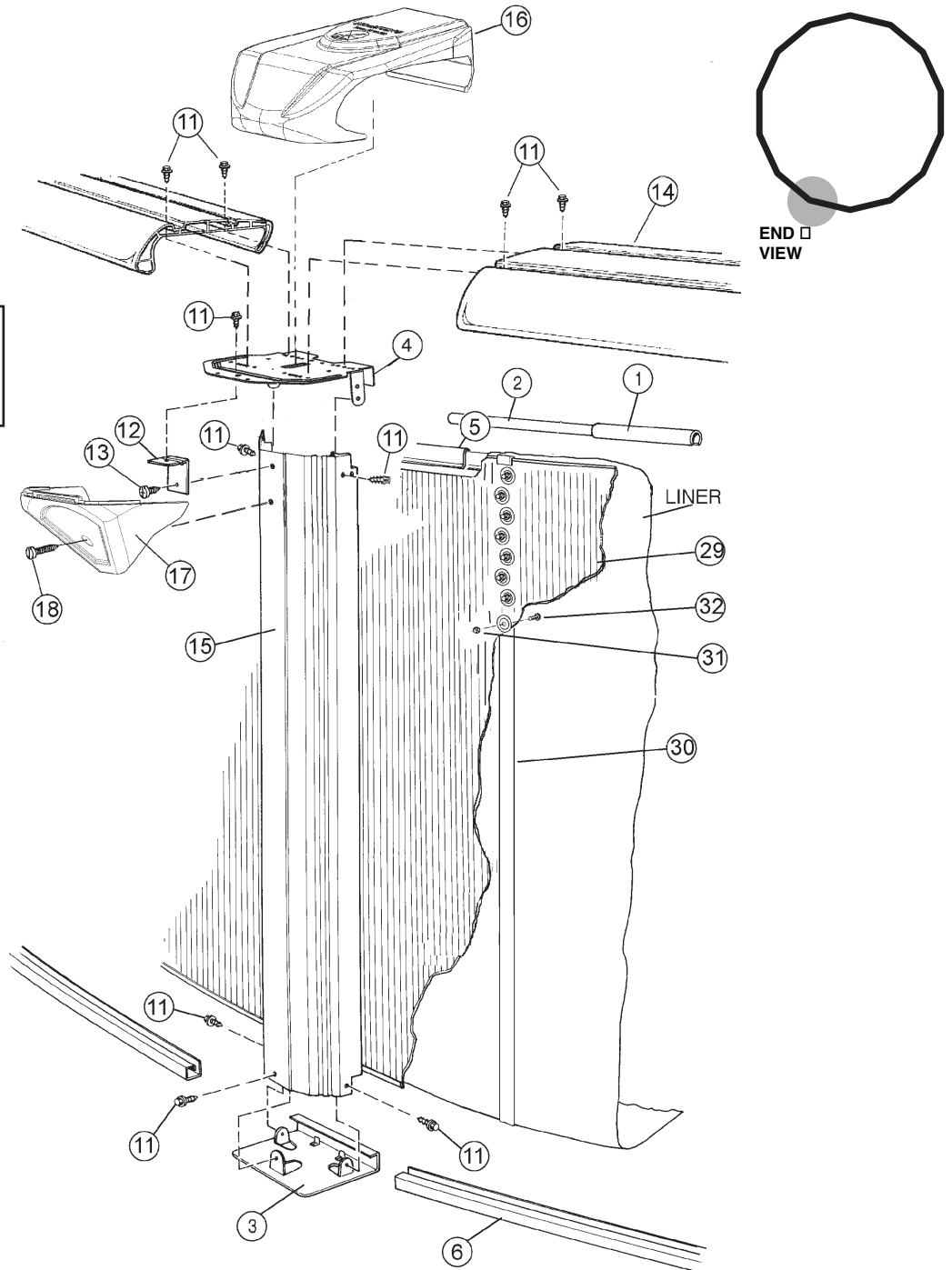

**Important!** Above-ground pools are designed for swimming and wading only. Do not Dive or Jump! Misuse of your pool may result in crippling injury and/or other dangers to life and health. Do not use slides, diving boards, or any other platform or object which can be used for improper pool entry. Use only an above-ground swimming pool ladder or entry system to enter or exit your pool. Never attempt to swim or reach behind ladders or any other pool entry system. It is the pool owner's responsibility to secure the pool against unauthorized, unsupervised or unintentional entry. It is also the pool owner's responsibility to warn all pool users of the hazards of diving into shallow water: paralyzing injury may result. Always obey all safety rules. Remember, pool safety is everybody's responsibility.

Safety decals and caution information provided with your pool have been endorsed by the U.S. Consumer Product Safety Commission. It is mandatory that the pool owner and installer follow the installation and use directions for all provided safety signs and decals. Juveniles must be supervised at all times by a responsible adult as directed by the USCPSC.

Change of Design: The manufacturer (Hill) expressly reserves the right to change or modify the design and construction of any product in due course of their manufacturing procedures, without incurring any obligation to furnish or install such changes or modifications on products previously or subsequently sold.