

*Please read and save these instructions. Read carefully before attempting to assemble, install, operate or maintain the product described. Protect yourself and others by observing all safety information. Failure to comply with instructions could result in personal injury and/or property damage! Retain instructions for future reference.*

# Heat Pump Pool and Spa Heater

## QUICK START GUIDE



Model ECO500

50,000 BTU Heat & Cool

## SECTION 1 - GENERAL INFORMATION

### CONTACTING

[www.ECOAQUAPRO.com](http://www.ECOAQUAPRO.com)

Phone (877) 278-2797  
8:00 a.m. to 5:00 p.m. Eastern time,  
Monday through Friday

Fax (888) 610-3839

### SAFETY

For personal safety, and to avoid damage to equipment, follow all safety instructions displayed in this guide. Repair and service of your heat pump must be performed by qualified service personnel. Failure to properly install, operate, maintain, or repair the heat pump will void factory warranty. Please note "**WARNING**" signals relate to personal safety, while "**CAUTION**" signals promote avoiding damage to equipment.

Follow all National Electric Codes (NEC) unless State or Local guidelines supersede. When installing and using your heat pump, basic safety precautions must always be followed

**WARNING** - Failure to heed the following may result in injury or death. Heat pumps contain no owner-repairable components. Electrical Installation should be by Licensed Electrician only. Service to the refrigerant circuit must be performed only by qualified HVAC Technicians. Heat pumps utilize high voltage and rotating equipment. Use caution when servicing. Heater contains refrigerant under pressure. Recover refrigerant before opening system. Prolonged immersion in water warmer than normal body temperature can cause fatal Hyperthermia. The use of alcohol, drugs, or medication can greatly increase the risk of fatal Hyperthermia. Persons having an adverse medical history, or pregnant women, should consult a physician before using a hot tub or spa. In addition, children and the extreme elderly should be supervised by a responsible adult.

**CAUTION** - Failure to heed the following may result in equipment damage. Improper water chemistry can cause damage to pump, filter, pool shell, etc. To avoid equipment damage, maintain Pool/Spa water per standards detailed later in this manual. Water flow exceeding max flow requires a bypass. Damage due to excessive water flow will void warranty.

## SAVE THESE INSTRUCTIONS

### WINTERIZING

In areas where freezing conditions are a rare occurrence, allow the filtration system to run continuously throughout the freeze period. Typically, during light freeze conditions, circulating (moving) water will not freeze. In areas where freezing conditions are prevalent and sustained, the heat pump must be winterized as follows:

- 1) Disconnect all electrical power to the heater; turn off circulating pump.
- 2) At the two (2) connection unions, disconnect the plumbing to the heater (removal is counter-clockwise).

3) If your unit has an external drain plug, remove plug. This plug would be located at lower, front corner of heater (position may vary between models). Allow water to drain out of the condenser. Replace the winterizing plug by threading the plug in clockwise until just snug, then apply an additional 1/8 turn.

4) If no drain plug is found, unit is self-draining from unions. Check online manuals for appropriate winterizing procedures on heat pumps older than 2005.

5) To prevent insects and vermin from entering the plumbing during the winterized period, partially reconnect the two (2) plumbing connection unions: couple each union one or two threads; this will permit condensation to drain, but will prevent most insects and animals from entering the plumbing circuit.

## **START UP**

To ready a winterized heat pump for use, simply retighten plumbing connection unions. Hand-tight is generally sufficient.

### **Warning**

- A. DO NOT use this unit for any other purpose than to regulate swimming pool water temperature. Utilization for any other application will void warranty.
- B. The inlet & outlet connection joint can not support any other piping system's weight.
- C. Make sure outlet air does not hurt any person, animal & plant.
- D. Please make sure to switch off the power before any examination and repair.

### **Precautions**

- A. The unit must be installed & maintained by professional technician, the Power layout must comply with local concerned regulation. Please read the manual carefully.
- B. Set proper temperature in order to get desired water temperature.
- C. Please do not stack substances that can block air flow near inlet or outlet area.
- D. The unit will automatically start up upon power available although power stop during operation.
- E. If the machine is stopped for a long time or in winter season please cut off the power supply and drain water clear of the machine by opening the tap of inlet pipe.
- F. Do not put your hand or pole into air outlet of evaporator, forbid to disassemble the working fan.
- G. If any abnormal status occurs such as abnormal noise, smell, smoke, electricity leakage, please switch off power immediately and contact your local dealer, please do not check the unit by yourself.
- H. Do not store combustible or flammable material near unit.

## **I. Application**

- 1- Set swimming pool water temp efficiently and economically to provide you comfort and pleasure
- 2- User may choose the model technical parameter according to professional guide, this series of swimming pool heater has been optimized in factory (refer to technical parameter table).

## Technical Parameters

Model	50HC
Heating capacity	50000 BTU
Cooling capacity	29000 BTU
Voltage 208-240v	
Frequency/phase – 60Hz/1 PH	
Compressor RLA/LRA	11.6A/60.2A
Fan motor rating	0.5 A
Refrigerant(R410A)	56.4oz
Noise	≤50 dB(A)

## Dimension

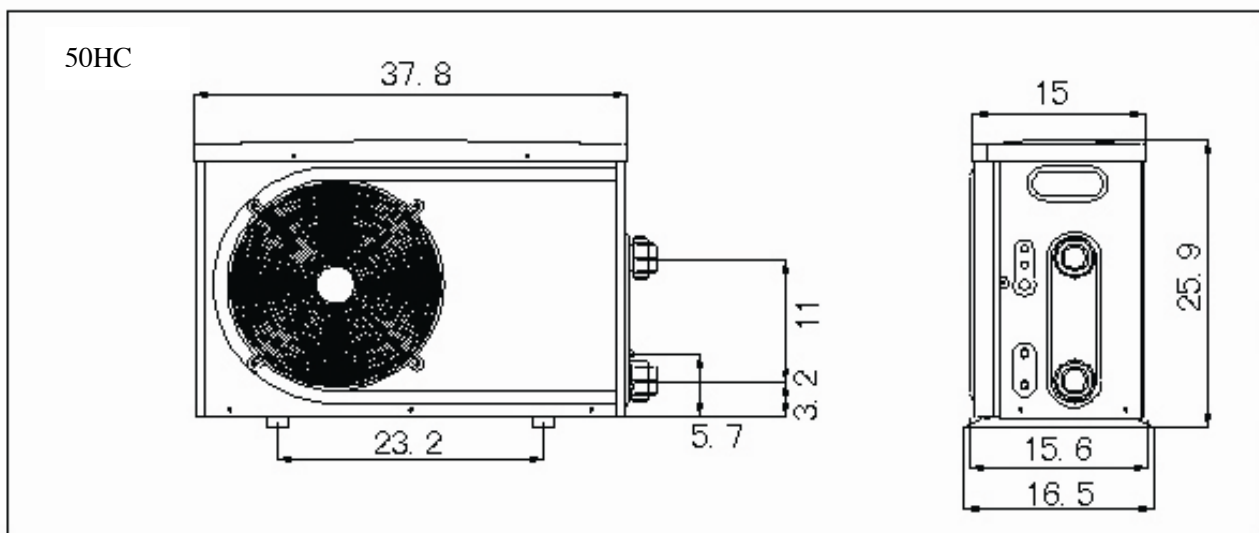

# 50000BTU

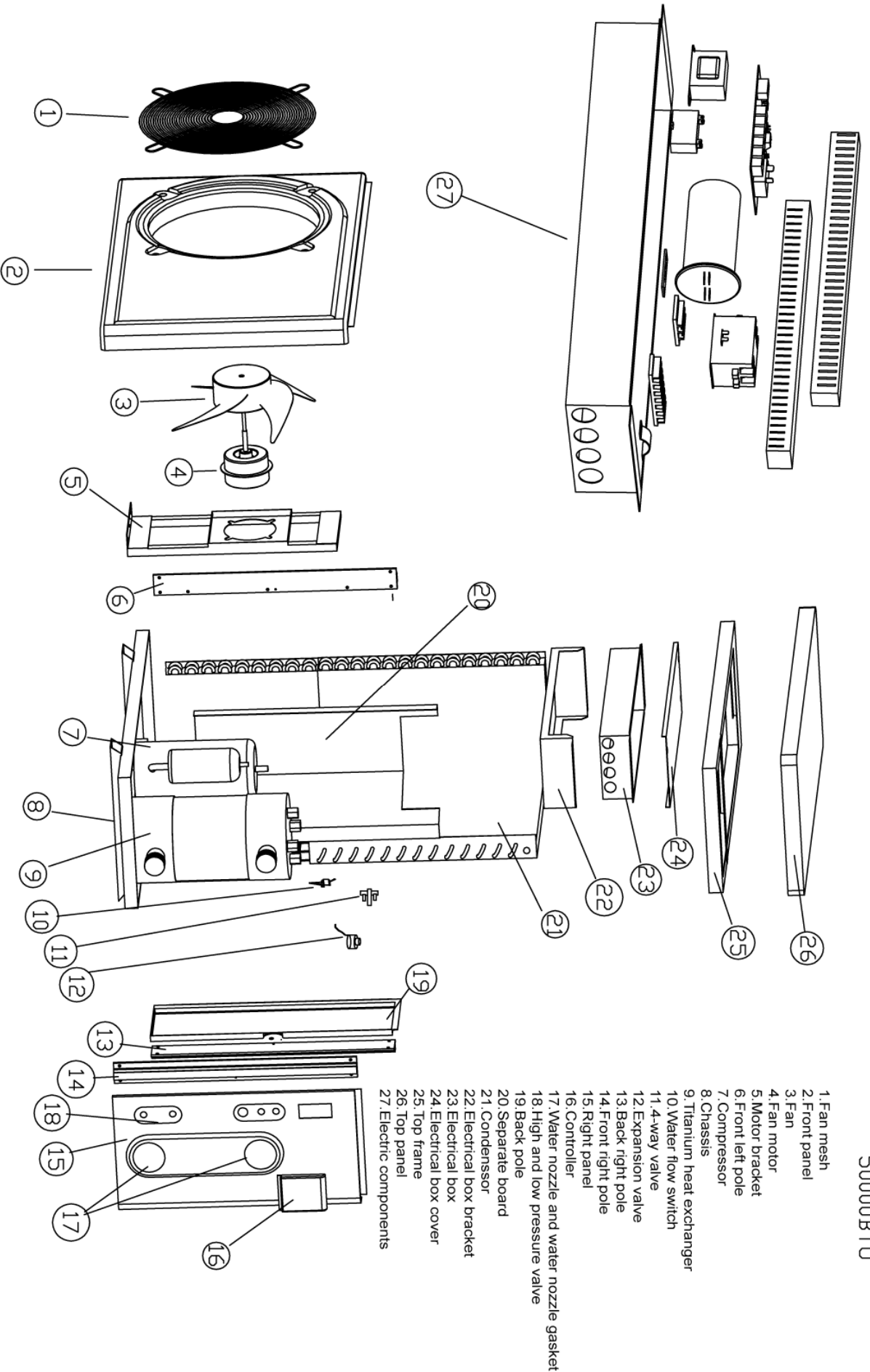

# Installation Guide

## 1. Electric Wiring Diagram

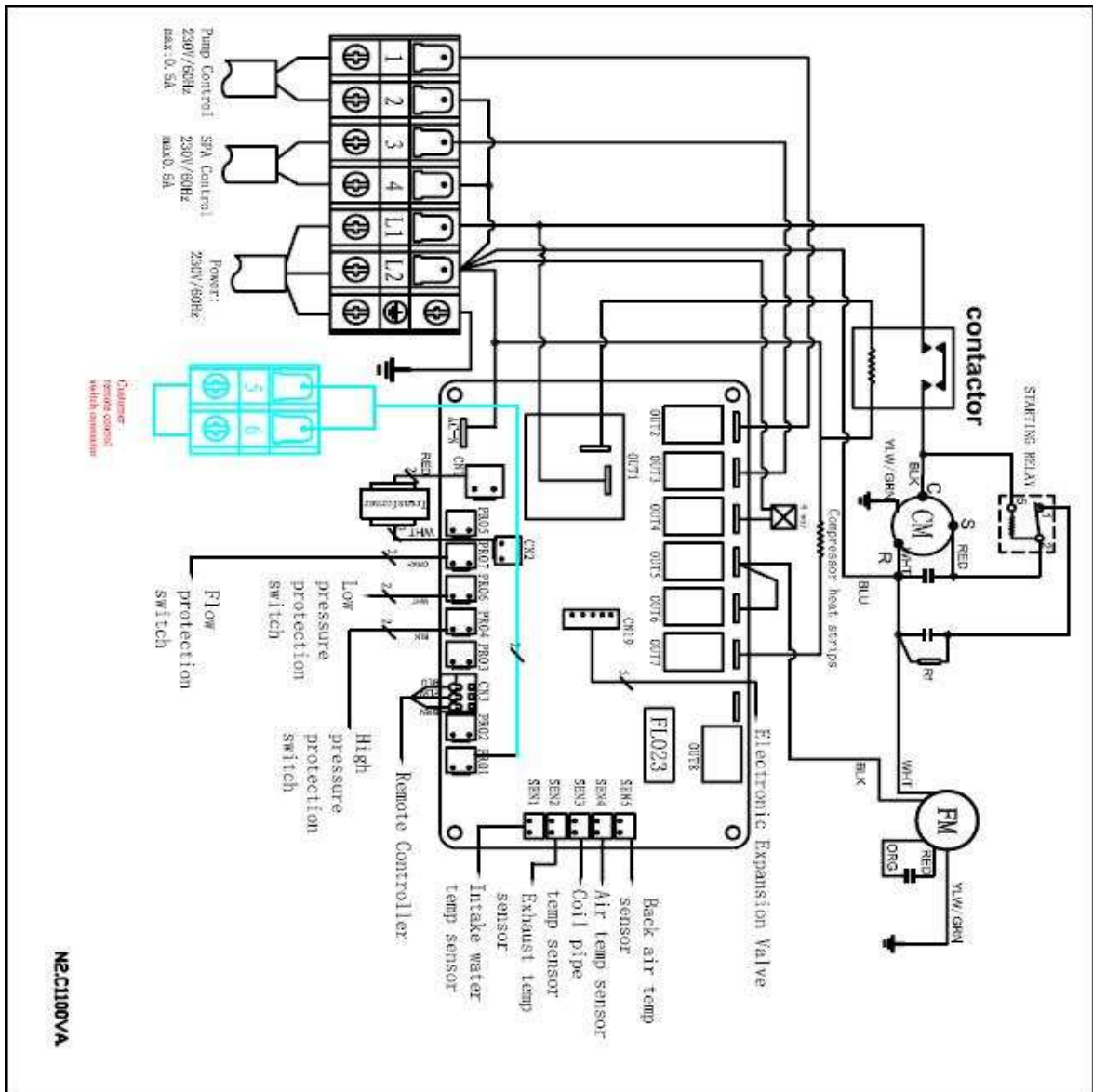

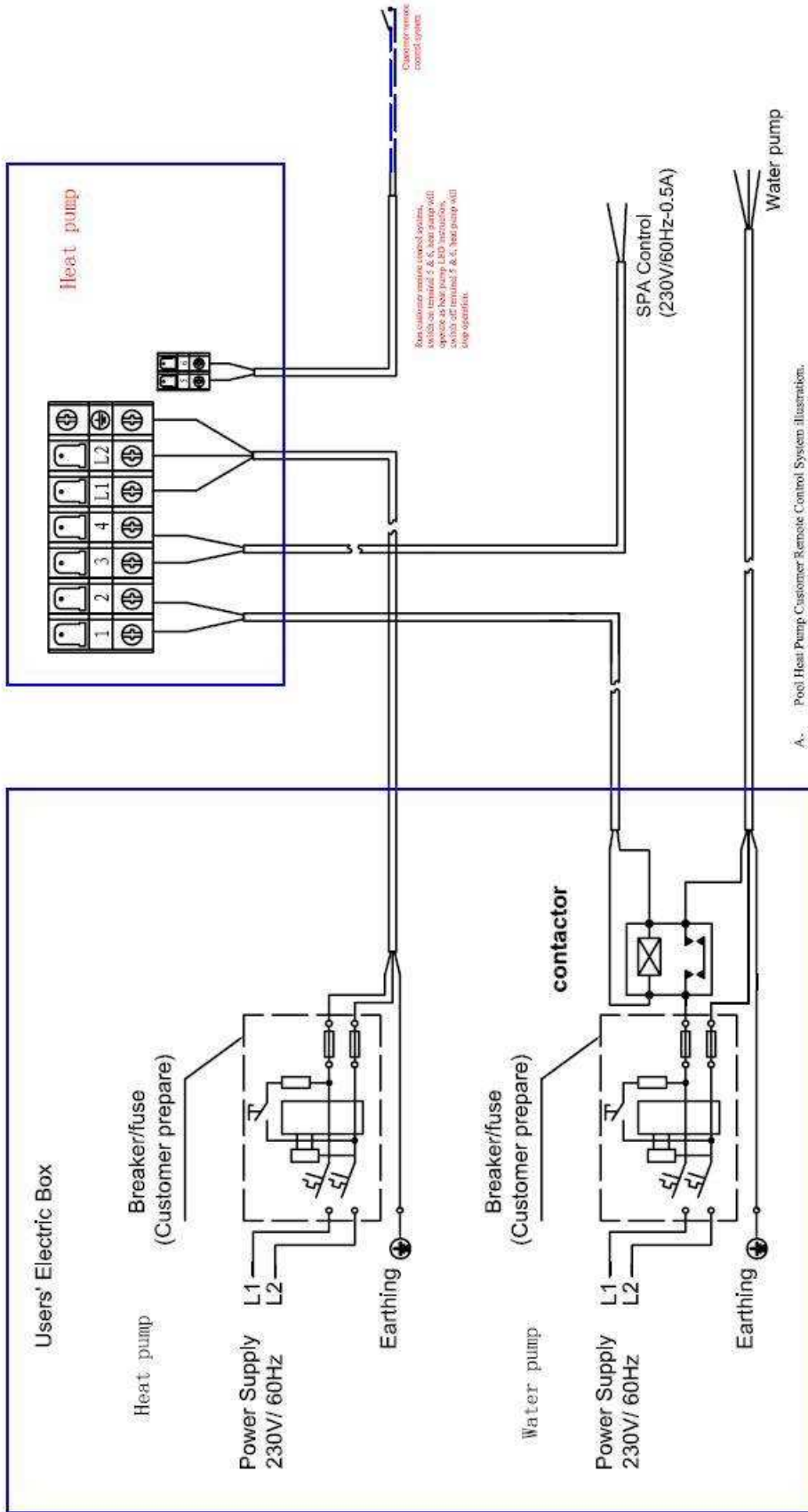

A. Pool Heat Pump Customer Remote Control System Illustration.

1. The 5 & 6 terminal are the connectors with switch of customer remote control system. If not operate this remote control system, pls connect terminal 5 & 6 with a wire.
2. If switch on 5 & 6 terminal from customer remote control system, heat pump will operate as instruction on LED of heat pump. LED indicator light up as current heat pump operation status. If switch off 5 & 6 terminal (not run customer remote control system), heat pump will stop. All indicators light out.

Pool Heat Pump Customer Remote Control System illustration.

- a. The 5 & 6 terminal are the connectors with switch of customer remote control system. If not operate this remote control system, pls connect terminal 5 & 6 with a wire.
- b. If switch on 5 & 6 terminal (run customer remote control system), heat pump will operate as instruction on LED of heat pump. LED indicator light up as current heat pump operation status.  
If switch off 5 & 6 terminal (not run customer remote control system), heat pump will stop. All indicators light out.

Run customer remote control system, switch on terminal 5 & 6, heat pump will operate as heat pump LED instruction, switch off terminal 5 & 6, heat pump will stop operation

## **2. Installation instruction and requirement**

The swimming pool heater must be installed by a professional. The users are not qualified to install by themselves, otherwise damage may happen to the heater or threat the body safety of the user.

### **A. Installation**

- 1-The swimming pool heater should be installed in a place with good ventilation;
- 2-The frame must be fixed by bolts to concrete foundation or brackets. The concrete foundation must be solid and fastened; the bracket must be strong enough antirust treated.
- 3-Please don't stack substances that will block air flow near inlet or outlet area, and there is no barrier within 50cm behind the main machine, or the efficiency of the heater will be reduced or even stopped.
- 4-When the machine is running, there will be condensation water discharged from the bottom, please pay attention to it. Please hold the drainage nozzle (accessory) into the hole and clip it well, and then connect a pipe to drain the condensation water out.

### **B. Wiring**

- 1-Connect to appropriate power supply; the voltage should comply with the rated voltage of the products. Earth the machine well.
- 2-Wiring must be handled by a professional technician according to the circuit diagram.
- 3-Set leakage protector according to the local code for wiring
- 4-The layout of power cable and signal cable should be orderly and not affecting each other.

C. Switch on after finishing all wiring construction and re-checking.



## Operation Instruction

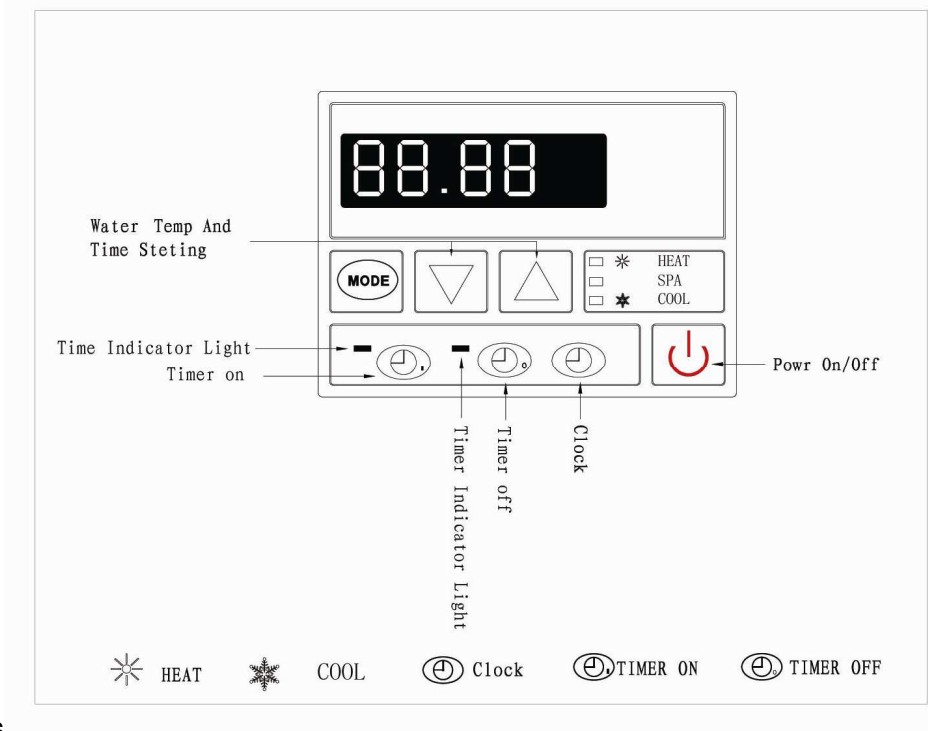





Picture for keys





## Operation Display

- The display shows Time when the machine is off
- The display shows Temperature of the swimming pool water when the machine is on.



Water temperature setting(Heating machine has no cooling function)







- Press MODE key can switch HEAT-SPA-COOL circulating mode.
- Available no matter the machine is on or off. Press HEAT or COOL light up.
- Press the key  or  to set water temperature. The controller indicates flashing temp. Press  or  to adjust to your desired water temp.
- 5 seconds later, the controller display will back to the normal mode.

SPA water temperature setting(For machine with spa function only):





- Available no matter the machine is on or off. Press MODE to SPA light up.
- Press the key  or  to set water temperature. The controller indicates flashing temp. Press  or  to adjust to your desired water temp
- 5 seconds later, the controller display will back to the normal mode.



Time setting (Military Based Time is USED – FYI)









- Available no matter the machine is on or off.
- Press  key to set time, when the clock on the screen is flashing, press  again to set

hour. Use  or  to adjust hour. Before the flashing stops, press  to set minute. Use  or  to adjust. After adjusting, press  and water temperature will be displayed. 30 seconds later, the controller display will be back to the normal mode.



Timer on and off

a. Press  set timer on. When the indicator light is on and the time is flashing, press  again to set hour. Use  or  to adjust. Before the flashing stops, press  to set minute.

b. Use  or  to adjust. After adjusting, press  and water temperature will be seen. 30 seconds later, the controller display will be back to the normal mode.

c. Press  to set timer off. When the indicator light is on and the time is flashing, press  again to set hour. Use  or  to adjust before flashing stop, press  to set minute. Use  or  to adjust. After adjusting, press  and water temperature will be seen. 30 seconds later, the controller display will be back to the normal mode.

Cancel timer on and off

Press  or  to cancel timer on and off. When the number is flashing, press  when timer indicator light is off and LED shows water temperature, the timer on and off is canceled. 30 seconds later, the controller display will be back to the normal mode.

Testing

## 1. Inspection before use

- A. Check installation of the whole machine and the pipe connections according to the pipe connecting drawing;
- B. Check the electric wiring according to the electric wiring diagram; and ground the connection.
- C. Make sure that the main machine power switch is off
- D. Check the temperature setting.
- E. Check the air inlet and outlet.

## 2. Troubleshooting

- A. The user must “Start the Pump before the Machine, And Turn off the Heat Pump before the Pump”, or the machine will be damaged.;
- B. The user should start the pump, check for any leakage of water; and then set suitable temperature in the thermostat, and then switch on power supply.

- C. In order to protect the swimming pool heater, the machine is equipped with a time lag starting function, when starting the heat pump, the blower will run 3 minutes earlier than the compressor.
- D. After the swimming pool heater starts up, check for any abnormal noise from the machine.

## **Precautions**

### **Attention**

- A. Set proper temperature in order to get comfortable water temperature; to avoid overheating or overcooling.
- B. Please don't stack substances that can block air flow near inlet or outlet area, or the efficiency of the heater will be reduced or even stopped.
- C. Please don't put hands into outlet of the swimming pool heater, and don't remove the screen of the fan at any time.
- D. If there are abnormal conditions such as noise, smell, smoke and electrical leakage, please switch off the machine immediately and contact the local dealer. Don't try to repair it yourself.
- E. Don't use or stock combustible gas or liquid such as thinners, paint and fuel to avoid fire.
- F. In order to optimize the heating effect; please install heat preservation insulation on pipes between swimming pool and the heater. During running period of the swimming pool heater, please use a recommended cover on the swimming pool.
- G. Connecting pipes of the swimming pool and the heater should be  $\leq 10\text{m}$ , or the heating effect of the heater cannot be ensured.

### **Safety**

- A. Please keep the main power supply switch far away from the children.
- B. When a power cut happens during running, and later the power is restored; the heater will start up automatically. So please switch off the power supply when there is a power cut, and reset temp when power is restored.
- C. Please switch off the main power supply in lightning and storm weather to prevent from machine damage that caused by lightning.
- D. If the machine is stopped for a long time please cut off the power supply and drain water clear of the machine by opening the tap of inlet pipe.

### **Maintenance**

- A. "Cut off" power supply of the heater before any examination and repair.
- B. In winter seasons, please drain water clear of the machine, "cut off" power supply to prevent any machine damage, and cover the machine body with plastic foil to avoid dust.
- C. Please clean this machine with household detergents or clean water, NEVER gasoline, thinners or any similar fuel.

D. Check bolts, cables and connections regularly.

### Trouble shooting for common faults

Faulty	Reason	Solutions
Not starting	Main power is off	Wait for power to be reinstated
	Switch off	Switch on
	Burnt out fuse	Replace it
	Circuit breaker drops out	Switch Circuit Breaker back on
There is air outlet but the heating is not satisfactory	Blocked air inlet	Clean out the stem
	Blocked air outlet	Clean out the stem
	3 minutes time lag protection	Please wait
	Temperature set too low	Increase temperature setting accordingly
If the above mentioned faults cannot be solved, please contact the professional and inform model and detailed faulty condition.		

Atten: Please don't disassemble and repair the swimming pool heater by yourself, please leave it to the professionals.

### Failure code

EE 1	High pressure protection
EE 2	Low pressure protection
EE 3	Low water pressure protection
EE 4	Over current (3 phase machine)
PP 1	Pool ( SPA )heater sensor failure
PP 2	Exhaust sensor failure
PP 3	Coil pipe sensor failure
PP 4	Intake pipe sensor failure
PP 5	Air temp sensor failure
PP 6	Compressor exhaust overload protection
PP 7	When the temperature<+32°F , auto stop protection ( not Failure )