

PENTAIR RAINBOW™ CHLORINE/BROMINE FEEDER MODEL #300-29X (FOR COMMERCIAL-SIZE APPLICATIONS)

Features:

- No special venting required.
- Completely enclosed-no escaping gases.
- Positive external no-clog chlorine control valve.
- No equipment damage.
- Feeds sanitizer directly to pool or spa.
- All parts replaceable.

YOUR LIFEGARD® FEEDER IS THE MOST EFFICIENT AND TROUBLE-FREE AUTOMATIC FEEDER YOU CAN BUY, BUT IT CAN ALSO BE DANGEROUS TO YOU AND YOUR EQUIPMENT. PLEASE FOLLOW INSTRUCTIONS EXACTLY AND HEED ALL CAUTIONS. YOUR SAFETY AND THE PROTECTION OF YOUR EQUIPMENT IS OUR FIRST CONCERN.

WHERE TO INSTALL YOUR FEEDER

IF YOUR POOL OR SPA HAS COPPER PLUMBING . . . STOP!!

Never install the feeder into copper plumbing as pipe damage could occur. Feeder should be installed **ABOVE POOL WATER LEVEL** whenever practical. If installed below water level these special instructions must be followed for safe and proper operation. When the feeder is installed below water level, two conditions must be overcome.

1. **ISOLATION OF THE FEEDER FROM POOL WATER:** The control valve when shut off to "off" isolates it on the side. A one way check valve such as the Rainbow R172324NS or other chemically resistant check valve will have to be attached on the discharge line at the top of the feeder.

NOTE: Never use any type of isolation valve on the discharge or outlet side of the feeder. Damage to the feeder will occur due to pressure build up. Use only a one-way corrosion resistance check valve. If isolation valves are used, remember to open them as soon as possible following recharging. Never leave closed for long periods of time as pressure will build up. Isolation is necessary to accomplish "DRAINING" in condition #2 which follows.

2. **DRAINING:** To prevent dangerous splash back of highly chlorinated water during recharging, the feeder will have to be emptied. There is a ½" MPT plug on side of feeder (see drawing) that can be removed for draining. To facilitate draining: A drain valve is available from your dealer. Details on back drawing.

The outlet line must be installed after the heater. If your pool does not have a heater, then it must be installed after the filter. **DAMAGE TO YOUR HEATER COULD RESULT IF HIGHLY CHLORINATED WATER FLOWS THROUGH IT. REFER TO INSTALLATION DRAWING FIGURE A**

Install the inlet line between the pump and filter. Detailed installation instructions follow in the next section.

IMPORTANT PLUMBING HINTS

All male pipe fittings must be wrapped with 3-4 turns of thread tape to act as a thread sealant. Always wrap counter-clockwise (opposite of direction to tighten) Never overtighten fittings, they are plastic and can be broken. Usually 2-3 turns past finger tight will prevent any leaks. A fitting can always be tightened more if it leaks but not once it is broken. Additional saddle clamps (Part No. R172264) may be required if plumbing is over 2" in diameter. Clamps can be interlocked. For plumbing 3" to 6" diameter, order saddle clamps (Part No. R172264XL). It is recommended that the Feeder be bolted down.)

1. Position feeder close to the filter and cut tubing to desired length. Be careful to cut tubing ends straight.

2. **ATTACH INLET LINE TO FEEDER.** Wrap ½" x short nipple with seal tape. Screw nipple into bottom ½" FPT hole in side of feeder. Screw control valve onto other end of nipple. Be careful not to overtighten. Wrap 90 degree tube fitting with thread tape and screw into valve. Push compression nut over tubing end of elbow. Push tubing onto tapered end of elbow. Tighten nut firmly by hand.

SEE DRAWING ON OTHER SIDE OF INSTRUCTION SHEET.

3. **ATTACH OUTLET LINE TO FEEDER.** Wrap 90 degree fitting with thread tape and screw into top ½" FPT hole on side of feeder. Push compression nut over tubing end, then push tubing onto tapered end of elbow. Tighten nut firmly by hand.

4. **INSTALL INLET LINE IN PLUMBING.** (Line to bottom side of feeder.) Turn off pump and timer switches. Drill 9/16" hole in plumbing, remove burrs and install saddle clamp assembly. Secure tubing to saddle clamp fitting by tightening clamp. Make sure clamp is below rib at end of saddle fitting. SEE DRAWING FIGURE A.

5. **INSTALL OUTLET LINE IN PLUMBING.** (Line from top of feeder.) Drill 9/16" hole in plumbing AFTER the heater and remove burrs. SEE DRAWING FIGURE A. Install saddle clamp assembly. Attach tubing as in #4 above. Installation is now complete.

SEE INSTALLATION DRAWING FIGURE A ON OTHER SIDE.

DIRECTIONS FOR USE

Before start up of feeder, your pool should be properly conditioned and the chlorine residual should be 1.0 to 1.5 ppm, (Bromine 2.0-4.0 ppm). The sanitizer demand in a pool varies and is dependent upon many factors; sunlight, bather load, water temperature, etc. As a result, the valve setting may have to be changed from time to time to conform to conditions. For example, the winter setting may be 2 and the summer setting may be 3. Recommended start setting #3. Check residual daily to find ideal valve setting. Note: Higher numbers dispense more sanitizer.

START UP INSTRUCTIONS

Exercise extreme caution when opening or servicing feeder. Do not inhale fumes. Wear protective gear. Follow manufacturer's suggestions for handling the chemical.

1. If below water level, close the control valve and drain any water in feeder by removing ¼" NPT plug in bottom, or by opening valve on optional drain kit. After draining, reinstall plug (use thread seal tape) or close drain valve.

2. Remove cap of feeder and fill with Trichlor or bromine tablets. For maximum dispensal rate use 1" diameter tablets, 3" tablets produce less than 40% of 1" tablets.

3. Making sure O-Ring is clean, lubricated with Lifeguard Silicone and is in place, replace cap. Hand tighten only.

4. Turn on pump and timer switches. Open control valve to #5 for one minute; which will allow feeder to fill with water. Adjust control valve according to your pool's size. Larger numbers dispense more sanitizer. The water in a newly filled pool should be properly conditioned to ensure maximum effectiveness of the Lifeguard Automatic Feeder. Consult your local pool dealer for water conditioning information in your area. Refer to tablet container for recommended residual. It is recommended that the sanitizer level be checked daily for the first 5 days. Remember that on hot days higher water temperature or increased pool activity will cause your pool to use more sanitizer. When possible, increase the feed a day or two in advance.

HOW TO RECHARGE

1. SHUT OFF PUMP AND TIMER SWITCHES. OPEN CONTROL VALVE TO #5 (If below water, level, see special instructions below.)

2. Remove cap; this will allow water and fumes to drain from feeder.

3. Fill with PROPER SIZE TABLETS (SEE START UP INSTRUCTIONS #2)

4. Making sure O-Ring is clean, lubricated with Lifeguard Silicone and is in place, replace cap. Hand tighten only.

5. Turn on pump and timer switches.

6. Leave control valve on #5 for one minute, this will allow feeder to fill with water. Reset control valve to original setting. Inspect inlet and outlet lines each time feeder is recharged. Replace lines yearly if necessary. Model 300-29X may require drain kit part #R172268 and a corrosion resistant check valve part #R172324. (See illustration)

BELOW WATER LEVEL RECHARGING INSTRUCTIONS

1. Shut off pump and timer switches.

2. Shut off control valve.

3. Place a clean container under drain and open drain valve.

4. Exercise extreme caution when opening or servicing feeder. Do not inhale fumes. Wear protective gear. Remove cap. water will now drain from feeder. Empty container back into pool or spa.

5. Close drain valve. Follow chemical manufacturer's recommendations for handling chemical used in your feeder. Fill with proper size tablets or sticks.

6. Making sure O-Ring is clean, lubricated with Lifeguard Silicone and is in place, replace cap. Hand tighten only.

7. Turn on pump and timer switches.

8. Reset control valve to original setting. Inspect inlet and outlet lines each time feeder is recharged. Replace lines yearly if needed.



DANGER

READ CAREFULLY

This feeder is designed to use only CLEAN Trichlor-s-trizinetriene OR CLEAN Bromine tables - slow dissolving type. Never use dirty tablets. **UNDER NO CIRCUMSTANCES MIX** Trichlor or Bromine with Calcium Hypochlorite, with other forms of concentrated chlorine or with other chemicals. Keep inside of feeder clean of dirt and debris at all times. **FIRE AND/OR EXPLOSION MAY RESULT.**

NEVER use oils or grease to lubricate o-ring. Oil in contact with Trichlor OR Bromine may result in **FIRE**. Lubricate o-ring with Lifeguard Silicone o-ring Lubricant ONLY, available at your dealers. If shock treatments or Algaecides containing chemicals other than sanitizers tablets in feeder must be used, turn off Feeder OR remove tablets until the shock or Algae treatment is complete and all granules have dissolved. Failure to do so may result in granules mixing in feeder causing **FIRE AND/OR EXPLOSION**. The shock or algae treatment dissolved in water is safe with tablets. If you are not the original owner of this feeder, not sure which chemicals was used, or if dirt and/or debris inside feeder, be **SAFE** and flush thoroughly with fresh water. **CAUTION SHOULD BE USED WHEN REMOVING CAP. DO NOT INHALE FUMES.**

CALCIUM HYPOCHLORITE IS NOT TO BE USED IN ANY FORM. Use of chemicals other than listed by manufacturer may be hazardous.



CAUTION

Do not install feeder into copper plumbing. Pipe damage could occur.
Never install feeder before heater.
Heater damage could occur.

#300-29X CHLORINE / BROMINE FEEDER PARTS BREAK DOWN DRAWING

Item	Qty.	Part No.	Description
1	1	R172008	3" Threaded cap
2	1	R172009	O-Ring cap
3	1	R172256	1/2" x Short MPT nipple
4	1	R172086	1/2" Chlorine control valve
5	2	R172272	1/2" 90° NPT x tube fitting w/nut
6	12'	R172269	1/2" ID Chlorinator tube
7	2	R175013	S/S tubing clamp
8	2	R172262	Saddle tube fitting
9	2	R172263	Saddle gasket
10	2	R172264	Saddle clamp
12	1	R172265	Body assy. w/stand #300-29
13	1	R172036	Silicone lubricant
14	Optional	R172052	Cap Wrench
15	1	R172324NS	1/2" Corrosion resistant check valve, tube x tube (ball)
16	1	R172134	1/2" MPT PVC plug
17	Optional	R172288	1 1/2"-2" Corrosion resistant check valve

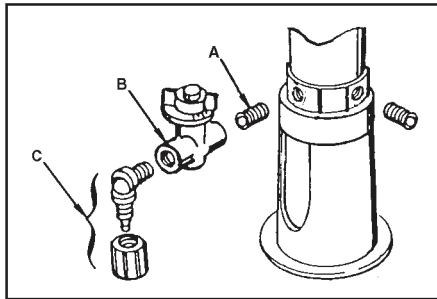
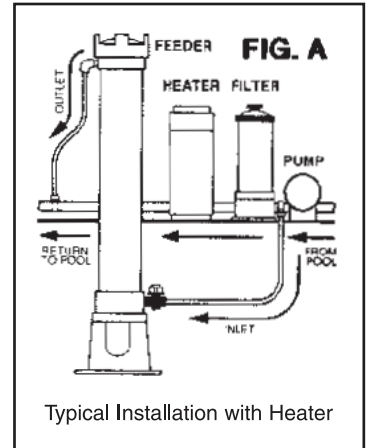
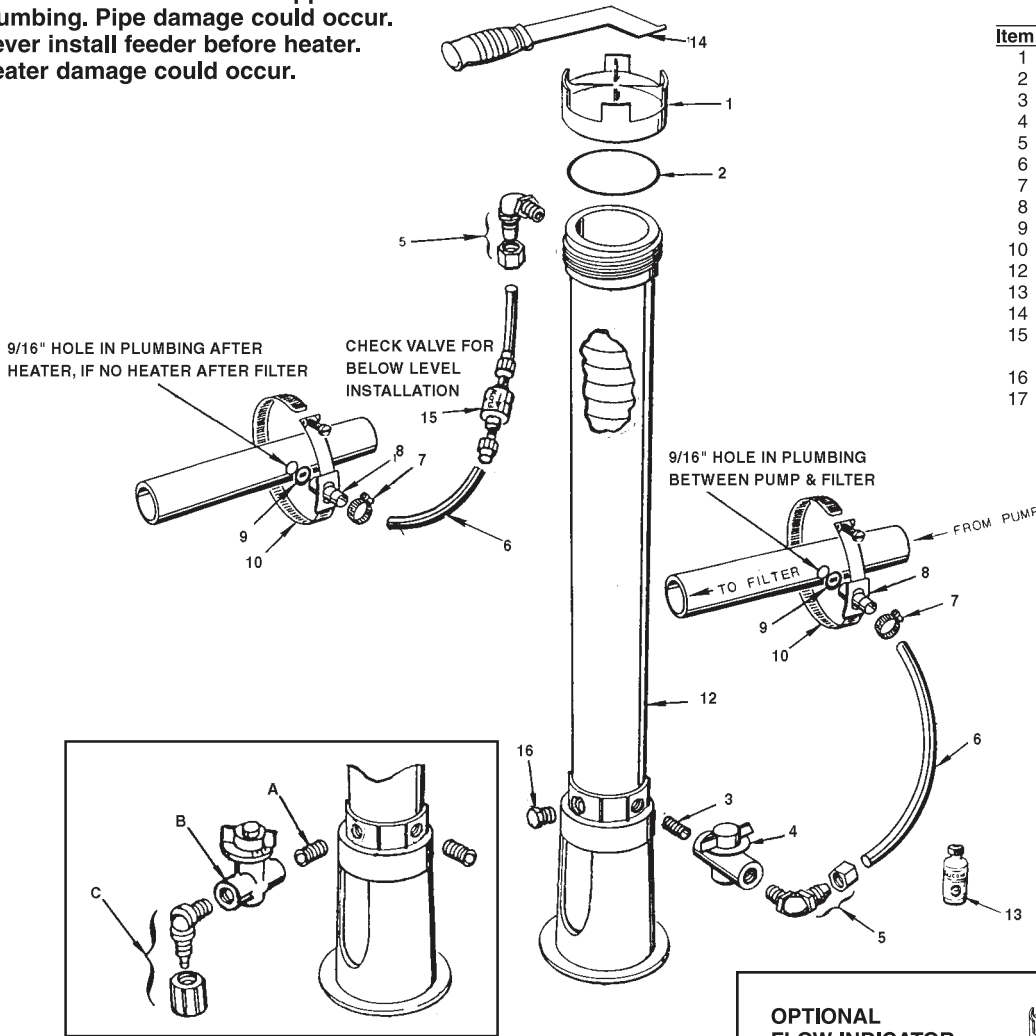

OPTIONAL DRAIN VALVE KIT #R172002

- A R172256 1/2" x Short MPT nipple
- B R172086 1/2" Control valve
- C R172272 1/2" 90° MPT x tube fitting w/nut

YOU MAY SUBSTITUTE BROMINE TABLETS OR STICKS FOR TRICHLOR IN THIS FEEDER. DO NOT MIX.

CALCIUM HYPOCHLORITE IS NOT TO BE USED IN ANY FORM.



NSF listed for public or residential use in Swimming Pools, Spas or Hot Tubs using Trichlor or Bromine and when used with a flow indicating device such as Rainbow Lifeguard Model #R172627.

OPTIONAL FLOW INDICATOR KIT INSTALLATION

If Flow indicator is used, a drain kit is required. (See Insert above optional drain kit).

CORROSION RESISTANT FLOW INDICATOR KIT No. R172627

Item	Part No.	Qty.	Description
1	R172276	1	Commercial Flow Indicator
1A	R172313	1	1/2" coupling (included with Flow indicator)
2	R270422	1	1/2" x 90° Elbow FPT
3	R72272	1	1/2" x 90° NPT x tube fitting with nut
4	R172628	1	Saddle clamp with inlet fitting
5	R172263	1	Saddle gasket
6	R172324	1	1/2" corrosion resistant check valve, tube x tube

EXTENSIONS

- Going on vacation?
- Need more chlorine?
- Filling Chlorinator/Brominator too frequently?

LIFEGARD CHLORINATOR EXTENSIONS SOLVE THE ABOVE PROBLEMS BY:

1. Increasing tablet capacity.
2. Larger chamber size allows more erosion of tablets. (See special instructions below)

The 10" extension doubles and the 20" extension triples (approximately) the capacity and time between refills. ***AVAILABLE THROUGH LIFEGARD DEALERS ONLY.**

NOTE: On free standing #300 series chlorinators, the base of the chlorinator should be secured to prevent the possibility of the chlorinator tipping over due to increased height.

INSTALLATION INSTRUCTIONS

1. Follow recharging instructions to the point of filling with tablets
2. Making sure O-Ring is clean, lubricated with Lifeguard Silicone and in place, screw on extension tightly and secure with lock screw. (You may wish to wait until back in operation before tightening screw to insure against leaks).
3. Fill with tablets and continue with normal recharging procedure.

SPECIAL INSTRUCTIONS:

The large chamber size will result in more chlorine being dispensed at the same valve setting, therefore, once installed, several days monitoring will be necessary to readjust chlorinator output.

*Does not apply to large capacity #300-19 or #300-29.

Parts Breakdown Drawing

Item	Quantity	Part No.	Description
1	1	R172078	Lockscrew (bottom collar)
2	1	R172009	O-Ring

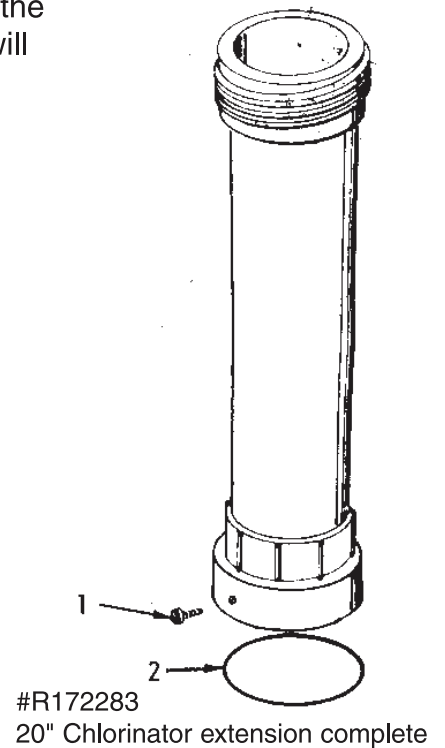
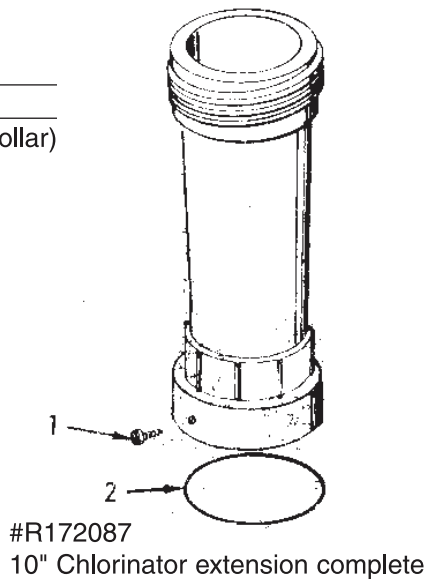

#R172323, #R172324 & #R172288 CHECK VALVE INSTALLATION INSTRUCTIONS

**FOR #300-29X CHLORINATOR: USE #R172324 1/2" CHECK VALVE
INSTEAD OF #R172323 1/4" CHECK VALVE AS SHOWN**

NOTE: MAKE SURE ALL PUMPS AND TIMER SWITCHES ARE IN THE OFF POSITION.

#R172323 * 1/4" CHECK VALVE &
#R172324 * 1/2" CHECK VALVE INSTALLATION:

1. Cut Chlorinator inlet line at desired location.
 2. Slide compression nut over one end of line. Make sure arrow on check valve is pointing toward Chlorinator, insert barbed end of check valve into line and tighten the nut finger tight. Repeat procedure for other end of check valve.
- #R172288 1 1/2" -2" CHECK VALVE INSTALLATION:
1. Cut piping at required location for your situation (refer to drawings).
 2. Making sure arrow on check valve is pointing away from equipment and in the direction of water flow to the pool/spa, glue in check valve using PVC solvent cement. 1 1/2" pipe will glue directly in valve, 2" pipe requires two 2" slip x slip couplings

WITH HEATER

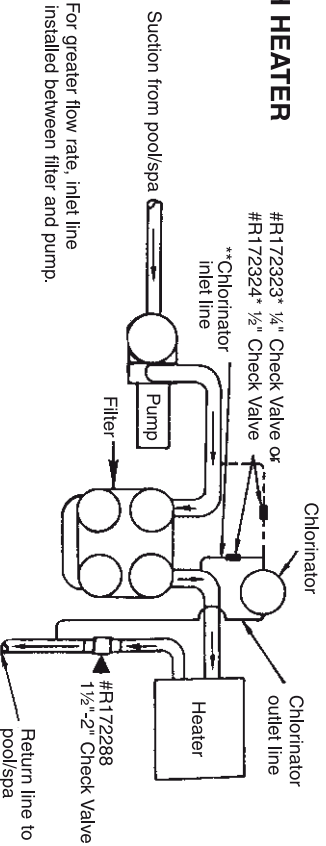

**Note: For greater flow rate, inlet line may be installed between filter and pump.

NOTE: If heaters are used, a FIREMAN'S SWITCH or equivalent must be installed to prevent possible damage and improper operation of CHECK VALVE and other equipment subject to heat damage.

WITHOUT HEATER

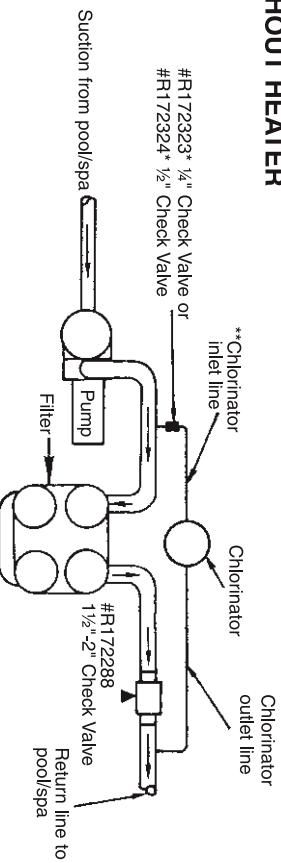

R24050-0402

1620 Hawkins Ave., Sanford, NC 27330 • (919) 566-8000
10951 West Los Angeles Ave., Moorpark, CA 93021 • (805) 553-5000

Rainbow LifeGuard™ and Pentair Water Pool and Spa® is a trademark and/or a registered trademark of Pentair Water Pool and Spa, Inc. and/or its affiliated companies in the United States and/or other countries. Unless noted, names and brands of others that may be used in this document are not used to indicate an affiliation or endorsement between the proprietors of these names and brands and Pentair Water Pool and Spa, Inc. Those names and brands may be the trademarks or registered trademarks of those parties or others.

EQUIPMENT SAFETY CAUTION PLEASE READ CAREFULLY

Since most pool plumbing is not airtight, and a mixture of air and chlorine is highly corrosive to metals, it is important to protect these items from corrosion in the OFF period when no circulation is taking place. (There is no chance for chlorine corrosion when the circulating system is in operation.)

Of course, corrosion or erosion of metal components can still occur independently of any chlorinator installation for the following reasons:

1. Water velocity too high.
2. Water pH less than 7.2.
3. Total alkalinity less than 100 PPM.

If your pool or spa has any of the following equipment, special plumbing procedures must be followed for safe operation:

1. Brass or bronze gate, rotary or backwash valves.
2. The preceding valves constructed of PVC or other plastic material with metallic shafts.
3. Filters, heaters, heat exchangers or other items with metallic tanks, shafts, coils or tubes.
4. **NOT FOR USE IN COPPER PLUMBING.**

Installation of the **OPTIONAL** Rainbow #R172288, #R172323* and #R172324* positive seal, corrosion resistant check valve **SHOWN ON REVERSE SIDE** will prevent the backflow of corrosive liquids and gases that can damage equipment containing metallic components. Examples listed above.

*Note: Valve size and tubing size must match.

WARNING: If your pool is equipped with a permanent built in pool-cleaning system, damage could occur to that system if materials are not compatible with low pH Tri-Chloro feeders. Check with manufacturer for compatibility.



© 2013 Pentair Water Pool and Spa, Inc. All rights reserved. Technical Support: (800) 831-7133



R24050-0402

R24294 Rev. D