

Super Pump® VS

Owner's Manual

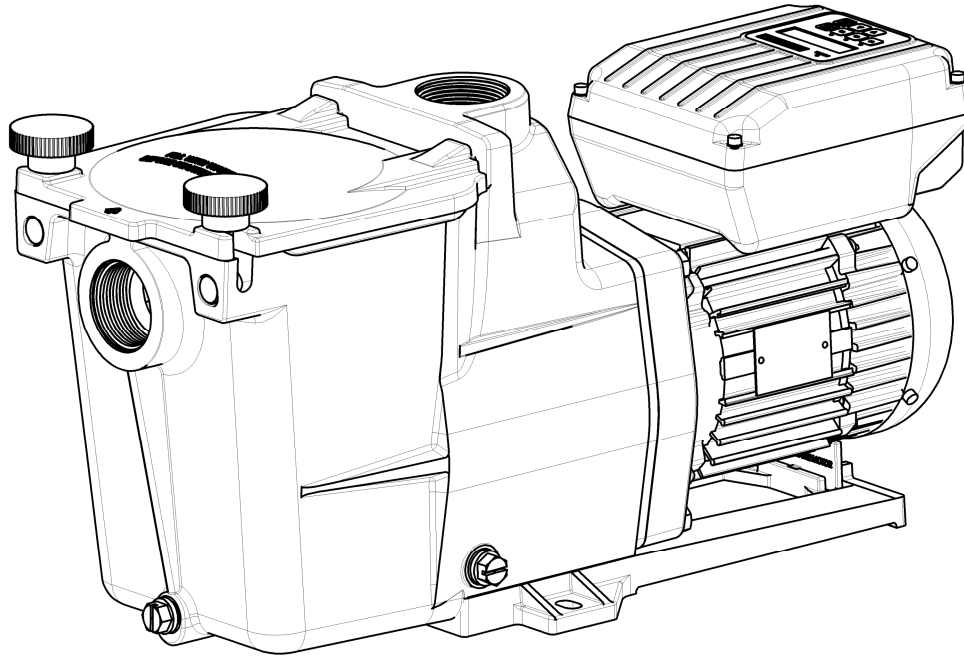

Model SP2600VSP
Super Pump Variable Speed Pump

The Hayward Super Pump VS is specifically engineered for the demanding requirements of today's in-ground swimming pool/spa that is equipped with large capacity filters, heaters, and pool cleaning equipment. The totally enclosed, permanent magnet motor combined with its advanced hydraulic design provides unparalleled energy savings. The Super Pump VS is a self-priming pump that incorporates an improved seal and impeller design that will provide many years of efficient, dependable, corrosion-free service. The advanced design provides superior performance while reducing maintenance requirements.

NOTE - To prevent potential injury and to avoid unnecessary service calls, read this manual carefully and completely.

SAVE THIS INSTRUCTION MANUAL

Hayward Pool Products
620 Division St, Elizabeth, NJ 07201
Phone: (908) 351-5400
www.haywardpool.com

VEUILLEZ VOUS REFERER AU SITE WEB HAYWARDPOOL.CA POUR LES INSTRUCTIONS EN FRANCAIS

Table of Contents

1.	IMPORTANT SAFETY INSTRUCTIONS	4
2.	General Information	7
2.1.	Introduction	7
2.2.	Primary Features	7
2.3.	Product Dimensions	7
3.	Energy Efficiency Overview	7
4.	Installation and Wiring	8
4.1.	Pump Location	8
4.2.	Pump Mounting	8
4.3.	Pipe Sizing Chart	9
4.4.	Plumbing	9
4.5.	Electrical	9
4.6.	Electrical Specs	10
4.7.	Voltage	10
4.8.	Grounding and Bonding	10
4.9.	Wiring	10
4.10.	Installation Procedure	10
5.	Wiring Diagrams.....	11
5.1.	Input Power Wiring	11
6.	Startup & Operation	11
6.1.	Prior to Start-Up	11
6.2.	Starting/Priming the Pump	11
6.3.	User Interface Summary	12
6.4.	Menu Outline	13
6.5.	Initial startup	13
6.6.	Configuration Menu	14
6.7.	Quick Speed Change	15
6.8.	Stop/Resume	16
6.9.	Error Display	16
6.10.	Service Mode	16
6.11.	Reset to Factory Settings	17
7.	Maintenance.....	17
8.	Storage / Winterization	17
8.1.	Storing Pump For Winterization	17
9.	Shaft Seal Change Instructions	18
9.1.	Removing the Motor Assembly	18
9.2.	Removing the Impeller	18
9.3.	Removing the Ceramic Seat	18
9.4.	Seal Installation	18
9.5.	Replacing the Impeller and Diffuser	18
9.6.	Replacing the Motor Assembly	19
10.	Replacement Parts	19
10.1.	Parts Diagram	19
11.	Troubleshooting.....	20

USE ONLY HAYWARD GENUINE REPLACEMENT PARTS





11.1. General Problems	20
11.2. Error Codes	22
12. Warranty.....	22
13. Product Registration.....	23

USE ONLY HAYWARD GENUINE REPLACEMENT PARTS

1. IMPORTANT SAFETY INSTRUCTIONS

Basic safety precautions should always be followed, including the following: Failure to follow instructions may result in injury.

 This is the safety-alert symbol. When you see this symbol on your pump or in this manual, look for one of the following signal words, and be alert to the potential for personal injury.

 **WARNING** warns about hazards that **could** cause serious personal injury, death or major property damage and if ignored presents a potential hazard.

 **CAUTION** warns about hazards that **will** or **can** cause minor or moderate personal injury and/or property damage and if ignored presents a potential hazard. It can also make consumers aware of actions that are unpredictable and unsafe.

The **NOTICE** label indicates special instructions that are important but not related to hazards.

Before installing or servicing this electrical equipment, turn power supply OFF.



 **WARNING – READ AND FOLLOW ALL INSTRUCTIONS** in this owner's manual and on the equipment. Failure to follow instructions can cause severe injury and/or death.

 **WARNING** – This product should be installed and serviced only by a qualified professional.

 **CAUTION** – All electrical wiring **MUST** be in conformance with all applicable local codes, regulations, and the National Electric Code (NEC).

USE OF NON-HAYWARD REPLACEMENT PARTS VOIDS WARRANTY.

ATTENTION INSTALLER - THIS MANUAL CONTAINS IMPORTANT INFORMATION ABOUT THE INSTALLATION, OPERATION, AND SAFE USE OF THIS VARIABLE SPEED PUMP THAT MUST BE FURNISHED TO THE END USER OF THIS PRODUCT. FAILURE TO READ AND FOLLOW ALL INSTRUCTIONS COULD RESULT IN SERIOUS INJURY.

 **WARNING** – To reduce risk of injury, do not permit children to use or climb on this product. Closely supervise children at all times. Components such as the filtration system, pumps, and heaters must be positioned to prevent children from using them as a means of access to the pool.

 **CAUTION** – This pump is intended for use on permanently installed swimming pools and may also be used with hot tubs and spas if so marked. Do NOT use with storable pools. A permanently installed pool is constructed in or on the ground or in a building such that it cannot be readily disassembled for storage. A storable pool is constructed so that it is capable of being readily disassembled for storage and reassembled to its original integrity. Though this product is designed for outdoor use, it is strongly advised to protect the electrical components from the weather. Select a well-drained area, one that will not flood when it rains. It requires free circulation of air for cooling. Do not install in a damp or non-ventilated location. If installed within an outer enclosure or beneath the skirt of a hot tub or spa, adequate ventilation and free circulation of air must be provided to prevent overheating of the motor.

USE ONLY HAYWARD GENUINE REPLACEMENT PARTS

 **WARNING** – Pool and spa components (seals, gaskets, etc.) have a finite life. All components should be inspected frequently and replaced at least every ten years, or if found to be damaged, broken, cracked, missing, or not securely attached.



 **WARNING – Risk of Electric Shock.** All electrical wiring **MUST** be in conformance with applicable local codes, regulations, and the National Electric Code (NEC). Hazardous voltage can shock, burn, and cause death or serious property damage. To reduce the risk of electric shock, do **NOT** use an extension cord to connect unit to electric supply. Provide a properly located electrical receptacle. Before working on pump or motor, turn off power supply to the pump.

 **WARNING** – To reduce the risk of electric shock replace damaged wiring immediately. Locate conduit to prevent abuse from lawn mowers, hedge trimmers and other equipment.

 **WARNING – Risk of Electric Shock.** In accordance with the National Electric Code (NEC), connect only to a branch circuit protected by a ground-fault circuit-interrupter (GFCI). Contact a qualified electrician if you cannot verify that the circuit is protected by a GFCI. The unit must be connected only to a supply circuit that is protected by a ground-fault circuit-interrupter (GFCI). Such a GFCI should be provided by the installer and should be tested on a routine basis. To test the GFCI, push the test circuit button. The GFCI should interrupt power. Push the reset button. Power should be restored. If the GFCI fails to operate in this manner, the GFCI is defective. If the GFCI interrupts power to the pump without the test button being pushed, a ground current is flowing, indicating the possibility of an electric shock. Do not use this pump. Disconnect the pump and have the problem corrected by a qualified service representative before using.

 **WARNING** – Failure to bond pump to pool structure will increase risk for electrocution and could result in injury or death. To reduce the risk of electric shock, see installation instructions and consult a professional electrician on how to bond pump. Also, contact a licensed electrician for information on local electrical codes for bonding requirements.

Notes to electrician: Use a solid copper conductor, size 8 or larger. Run a continuous wire from external bonding lug to reinforcing rod or mesh. Connect a No. 8 AWG (8.4 mm²) [No. 6 AWG (13.3 mm²) for Canada] solid copper bonding wire to the pressure wire connector provided on the pump housing and to all metal parts of swimming pool, spa, or hot tub, and to all electrical equipment, metal piping (except gas piping), and conduit within 5 ft. (1.5 m) of inside walls of swimming pool, spa, or hot tub. **IMPORTANT** - Reference NEC codes for all wiring standards including, but not limited to, grounding, bonding and other general wiring procedures.

 **WARNING – Suction Entrapment Hazard.** Suction in suction outlets and/or suction outlet covers, which are damaged, broken, cracked, missing, or unsecured cause severe injury and/or death due to the following entrapment hazards (symbols complements of APSP):



Hair Entrapment - Hair can become entangled in suction outlet cover.



Limb Entrapment - A limb inserted into an opening of a suction outlet sump or suction outlet cover that is damaged, broken, cracked, missing, or not securely attached can result in a mechanical bind or swelling of the limb.



Body Suction Entrapment - A differential pressure applied to a large portion of the body or limbs can result in an entrapment.



Evisceration/ Disembowelment - A negative pressure applied directly to the intestines through an unprotected suction outlet sump or suction outlet cover which is damaged, broken, cracked, missing, or unsecured can result in evisceration/disembowelment.

Mechanical Entrapment - There is potential for jewelry, swimsuits, hair decorations, fingers, toes, or knuckles to be caught in an opening of a suction outlet cover resulting in mechanical entrapment.

USE ONLY HAYWARD GENUINE REPLACEMENT PARTS

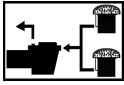
 **WARNING** – To Reduce the risk of Entrapment Hazards:

- When outlets are small enough to be blocked by a person, a minimum of two functioning suction outlets per pump must be installed. Suction outlets in the same plane (i.e. floor or wall), must be installed a minimum of three feet (3') [0.91 meter] apart, as measured from near point to near point.
- Dual suction fittings shall be placed in such locations and distances to avoid “dual blockage” by a user.
- Dual suction fittings shall not be located on seating areas or on the backrest for such seating areas.
- The maximum system flow rate shall not exceed the values shown in the “Pipe Sizing Chart” found in section 4.3 below.
- Never use pool or spa if any suction outlet component is damaged, broken, cracked, missing, or not securely attached.
- Replace damaged, broken, cracked, missing, or not securely attached suction outlet components immediately.
- In addition to two or more suction outlets per pump installed in accordance with latest APSP standards and CPSC guidelines, follow all national, state, and local codes applicable.
- Installation of a vacuum release or vent system, which relieves entrapping suction, is recommended.





 **WARNING – Hazardous Pressure.** Pool and spa water circulation systems operate under hazardous pressure during start-up, normal operation, and after pump shut-off. Stand clear of circulation system equipment during pump start-up. Failure to follow safety and operation instructions could result in violent separation of the pump housing and cover due to pressure in the system, which could cause property damage, severe personal injury, or death. Before servicing pool and spa water circulation system, all system and pump controls must be in off position and filter manual air relief valve must be in open position. Before starting pump, all system valves must be set in a position to allow system water to return back to the pool. Do not change filter control valve position while pump is running. Before starting pump, fully open filter manual air relief valve. Do not close filter manual air relief valve until a steady stream of water (not air or air and water mix) is discharged from the valve. All suction and discharge valves **MUST** be OPEN when starting the circulation system. Failure to do so could result in severe personal injury and/or property damage.



 **WARNING – Separation Hazard.** Failure to follow safety and operation instructions could result in violent separation of pump components. Strainer cover must be properly secured to pump housing with strainer cover lock ring. Before servicing pool and spa circulation system, all system and pump controls must be in off position and filter manual air relief valve must be in open position. Do not operate pool and spa circulation system if a system component is not assembled properly, damaged, or missing. Do not operate pool and spa circulation system unless filter manual air relief valve body is in locked position in filter upper body. All suction and discharge valves **MUST** be OPEN when starting the circulation system. Failure to do so could result in severe personal injury and/or property damage.

 **WARNING** – Never operate the circulation system at more than 50 PSI maximum.

 **WARNING – Fire and burn hazard.** Motors operate at high temperatures and if they are not properly isolated from any flammable structures or foreign debris they can cause fires, which may cause severe personal injury or death. It is also necessary to allow the motor to cool for at least 20 minutes prior to maintenance to minimize the risk for burns.

 **WARNING** – Failure to install according to defined instructions may result in severe personal injury or death.

SAVE THESE INSTRUCTIONS

USE ONLY HAYWARD GENUINE REPLACEMENT PARTS

2. General Information

2.1. Introduction

This manual contains information for the proper installation and operation of the Hayward Super Pump Variable Speed Pump. The instructions in this manual **MUST** be followed precisely.

2.2. Primary Features

- Totally enclosed, permanent magnet motor
- Advanced hydraulic design
- Fully programmable with up to 3 custom speed and timer functions
- Motor drive includes built-in protection for high temperatures and voltage fluctuations. Drive is also designed to withstand temperatures below freezing without issue

2.3. Product Dimensions

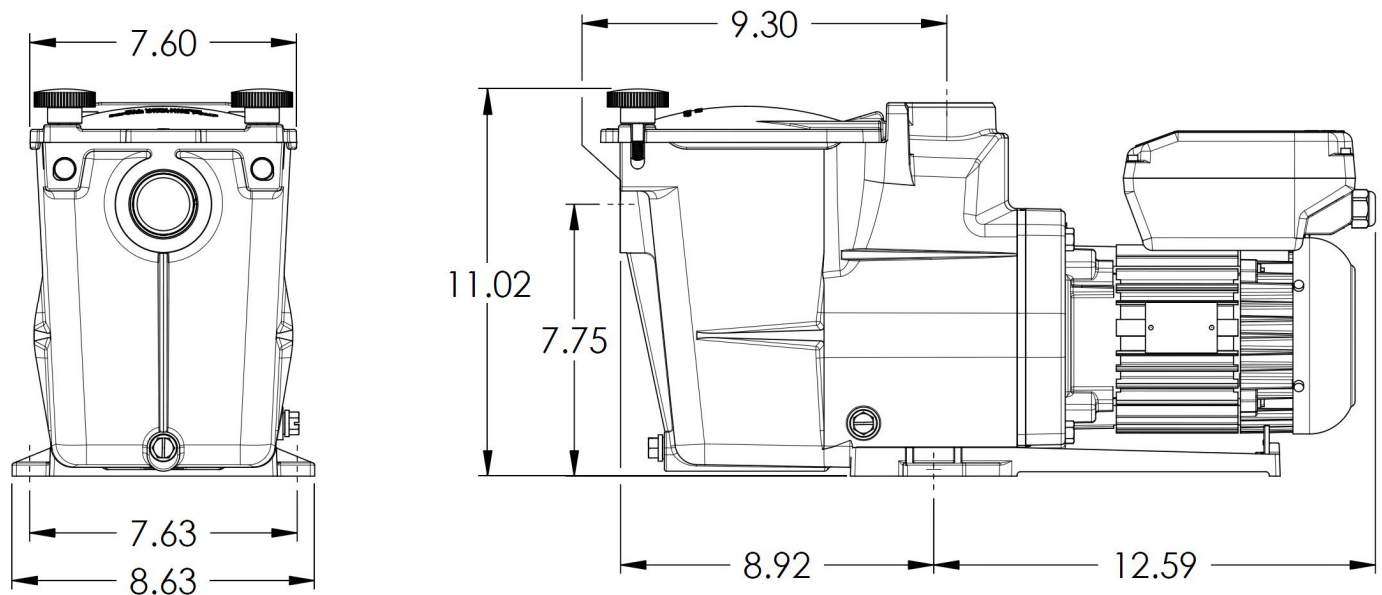

3. Energy Efficiency Overview

The energy consumed by a pool pump is measured in terms of Watts (W) or Kilowatts (kW). The Super Pump VS displays power consumption in Watts. Given this information, you can determine the cost of operating the pump:

Power consumption of pump X Cost of electricity = Cost of Pump Operation per Hour

Example: Super Pump Variable Speed Pump operating at 370 W. Cost of electricity = \$0.10 per kWh
Convert Watts to Kilowatts: 370 W = 0.370 kW
0.370 kW X \$0.10/kWh = \$0.04 per hour

Note the power consumption is greatly affected by the speed of the pump. Lowering the speed of the pump can drastically reduce the power that is consumed. Below are some of the major benefits of running the pump at lower speeds.

USE ONLY HAYWARD GENUINE REPLACEMENT PARTS

Benefits of running at low speeds

- Save electricity and money
- Improved filtration – the filter can often remove smaller particles when the water moves slower
- Quiet operation
- Reduced Total Dynamic Head – less stress on equipment (e.g. filter) which can lengthen equipment life

When determining the speed(s) to operate your pump, you must also take into account the minimum requirements for proper sanitation and equipment/water feature functionality.

It is recommended you filter (“turnover”) all the water in the pool at least once every 24 hours. Check with local requirements for the minimum turnover rate. Running the pump at a lower speed may require running the pump for a longer period of time in order to meet the turnover requirements for proper sanitation.

Equipment such as heaters, skimmers, and chlorinators require minimum flows to operate correctly. Refer to individual equipment manuals for specific flow requirements.

After setting the pump speed(s), it is recommended you check that all other equipment/water features are functioning as intended. For example, when running at a low speed for daily filtration, verify water is adequately flowing over the skimmer weirs. Operate the pump at higher speeds for the shorter periods of time needed to operate a heater, water feature, etc.

4. Installation and Wiring

 **WARNING** – This product should be installed and serviced only by a qualified professional.

4.1. Pump Location

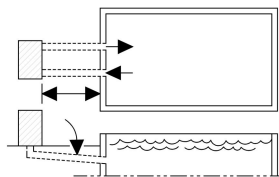

Locate pump as close to pool as practical and run suction lines as direct as possible to reduce friction loss. Suction lines should have continuous slope upward from lowest point in line. Joints must be tight (but not over-tightened). Suction line diameter must equal or be larger than the discharge line diameter.

Though the pump is designed for outdoor use, it is advised to place pump and filter in the shade to shield them from continuous direct heat. Select a well-drained area that will not

flood when it rains. Do NOT install pump and filter in a damp or non-ventilated location. Keep motor clean. Pump motors require free circulation of air for cooling.

4.2. Pump Mounting

Install pump on a level concrete slab or other rigid base to meet all local and national codes. Secure pump to base with screws or bolts to further reduce vibration and stress on pipe or hose joints. The base must be level, rigid, and vibration free.

Pump mount must:

- Allow pump inlet height to be as close to water level as possible.
- Allow use of short, direct suction pipe (to reduce friction losses).
- Allow for valves in suction and discharge piping.
- Be protected from excess moisture and flooding.
- Allow adequate access for servicing pump and piping.

USE ONLY HAYWARD GENUINE REPLACEMENT PARTS

4.3. Pipe Sizing Chart

MAXIMUM RECOMMENDED SYSTEM FLOW RATE BY PIPE SIZE		
Pipe Size in. [mm]	Maximum Flow Rate GPM [LPM]	Minimum Straight Pipe Length "L" in. [mm] *
1 1/2" [50]	45 [170]	7 1/2" [190]
2" [63]	80 [300]	10" [254]
2 1/2" [75]	110 [415]	12 1/2" [317]
3" [90]	160 [600]	15" [381]

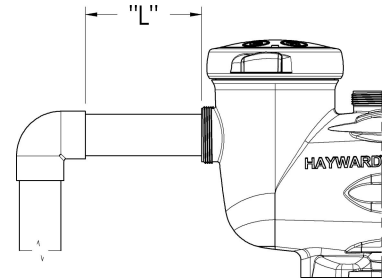

*** Note:** It is recommended that a minimum length of straight piping (shown as "L" in above diagram), equivalent to 5 pipe size diameters, be used between the pump suction inlet and any plumbing fittings (elbows, valves, etc.).

When installing the Super Pump VS, care should be taken to ensure proper pipe and equipment sizing to handle the maximum flow required. It is recommended to set the maximum speed in order to not exceed the maximum flow rate. See note at end of section 6.6.



WARNING – Hazardous Pressure. Pumps, filters, and other equipment/ components of a swimming pool filtration system operate under pressure. Incorrectly installed and/or improperly tested filtration equipment and/or components may fail resulting in severe personal injury or death.

4.4. Plumbing

1. Use Teflon tape to seal threaded connections on molded plastic components. All plastic fittings must be new or thoroughly cleaned before use. NOTE - Do NOT use Plumber's Pipe Dope as it may cause cracking of the plastic components. When applying Teflon tape to plastic threads, wrap the entire threaded portion of the male fitting with one to two layers of tape. Wind the tape clockwise as you face the open end of the fitting, beginning at the end of the fitting. The pump suction and outlet ports have molded-in thread stops. Do NOT attempt to force hose connector fitting past this stop. It is only necessary to tighten fittings enough to prevent leakage. Tighten fitting by hand and then use a tool to engage fitting an additional 1 1/2 turns. Use care when using Teflon tape as friction is reduced considerably; do NOT over-tighten fitting or you may cause damage. If leaks occur, remove connector, clean off old Teflon tape, re-wrap with one to two additional layers of Teflon tape, and re-install connector.
2. Fittings (elbows, tees, valves, etc.) restrict flow. For better efficiency, use the fewest possible fittings. Avoid fittings that could cause an air trap. Pool and spa fittings MUST conform to the International Association of Plumbing and Mechanical Officials (IAPMO) standards.

4.5. Electrical



WARNING – All electrical wiring MUST conform to local codes, regulations, and the National Electric Code (NEC).

WARNING – Ground and bond pump before connecting to electrical power supply. Failure to ground and bond pump can cause serious or fatal electrical shock hazard. Do NOT ground to a gas supply line. To avoid dangerous or fatal electrical shock, turn OFF power to pump before working on electrical connections. Fire Hazard - match supply voltage to pump nameplate voltage. Insure that the electrical supply available agrees with the pump's voltage, phase, and cycle, and that the wire size is adequate for the amps rating and distance from the power source. Use copper conductors only.

USE ONLY HAYWARD GENUINE REPLACEMENT PARTS

4.6. Electrical Specs

1. Voltage: 230VAC, 60Hz, Single Phase
2. Amps: 5.9
3. Speed Range: 600-3000 rpm

Use copper conductors only. For indoor & outdoor use. Connect pump to a 15 amp branch circuit in accordance with local codes, regulations, and the National Electric Code (NEC). A disconnecting means located at least 5 ft. from the inside wall of the pool, spa, or hot tub must be provided.

4.7. Voltage

Voltage at pump **MUST NOT** be more than 10% above or below nameplate rated voltage, or components may overheat, causing overload tripping and reduced component life. If voltage is less than 90% (207 V) or more than 110% (253 V) of rated voltage (230 V) when pump is running at full load, consult the power company.

4.8. Grounding and Bonding

1. Install, ground, bond, and wire pump in accordance with local or national electrical code requirements.
2. Permanently ground pump. Use green ground terminal provided under access plate; use size and type wire required by code. Connect ground terminal to electrical service ground.
3. Bond pump to pool structure. Bonding will connect all metal parts within and around the pool with a continuous wire. Bonding reduces the risk of a current passing between bonded metal objects, which could potentially cause electrical shock if grounded or shorted. Reference NEC codes for all wiring standards including, but not limited to, grounding, bonding and general wiring procedures.
4. Use a solid copper conductor, size 8 or larger. Run wire from external bonding lug to reinforcing rod or mesh. Connect a No. 8 AWG (8.4 mm²) [No. 6 AWG (13.3 mm²) for Canada] solid copper bonding wire to the pressure wire connector provided on the motor housing and to all metal parts of swimming pool, spa, or hot tub, and to all electrical equipment, metal piping (except gas piping), and conduit within 5 ft. (1.5 m) of inside walls of swimming pool, spa, or hot tub.

4.9. Wiring

 **WARNING** – All electrical wiring **MUST** conform to local codes, regulations, and the National Electric Code (NEC).

1. Pump **MUST** be permanently connected to circuit. If other lights or appliances are also on the same circuit, be sure to add their amp loads before calculating wire and circuit breaker sizes. Use the circuit breaker as the master On-Off switch.

4.10. Installation Procedure

Please review sections 4.1 through 4.9 before continuing with this section.

1. **TURN OFF THE ELECTRICAL POWER AT THE CIRCUIT BREAKER.**
2. Remove the wiring access cover on the motor drive. This is done by removing the four (4) screws on the top of the cover using a 3mm hex wrench. Note, be careful not to pull on the wires going to the controller when removing.
3. Connect 230VAC line power supply wiring to the terminal block and ground screw as shown in the Input Power Wiring diagram. See section 5.1 for diagram.

USE ONLY HAYWARD GENUINE REPLACEMENT PARTS

4. Connect the pump to the pool bonding system using 8AWG (6AWG for Canada) wire. A lug for bonding is provided on the outside of the drive enclosure.
5. After all electrical connections have been made, replace the wiring access cover on the motor drive ensuring that the motor lead wires are routed such that the wiring access cover can be installed and seated fully without interference. Tighten the supplied screws on the access cover.
6. Apply power to the system, and proceed to “Configuration Menu”, section 6.6.

5. Wiring Diagrams

5.1. Input Power Wiring

Figure 5.1-1

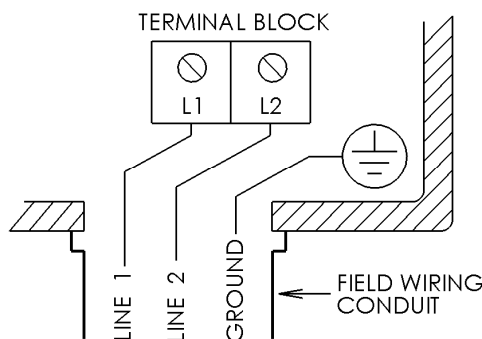

ATTENTION: ROUTE WIRING DIRECTLY FROM FIELD CONDUIT TO TERMINAL BLOCK AS SHOWN. DO NOT BUNDLE EXCESS WIRING INSIDE DRIVE ENCLOSURE.

- USE COPPER CONDUCTORS ONLY
- ACCEPTABLE FOR FIELD WIRING
- NOT SUITABLE FOR USE WITH RIGID METAL CONDUIT

- REMOVE TEST LEADS PRIOR TO INSTALL

6. Startup & Operation

6.1. Prior to Start-Up

If it is necessary to perform a water pressure test prior to initial use to ensure plumbing system is functioning properly, then the following criteria should be maintained for this test:

1. Have a professional perform this test.
2. Ensure all Hayward pump and system components are removed from system prior to performing test.

⚠ WARNING – If circulation equipment must remain in the plumbing system during water pressure test, do not apply more than 10 psi pressure to the system. Be sure water pressure has been released, using the filter manual air relief valve, before removing pump strainer cover.

⚠ WARNING – All suction and discharge valves **MUST** be OPEN, as well as filter air relief valve (if available) on filter, when starting the circulating pump system. Failure to do so could result in severe personal injury.

6.2. Starting/Priming the Pump

Refer to section 6.6 for priming mode selection.

Fill strainer housing with water to suction pipe level. If water leakage occurs from anywhere on the pump or filter, DO NOT start the pump. If no leakage occurs, stand at least 10 feet from pump and/or filter and proceed with starting the pump.

⚠ WARNING – Return to filter to close filter manual air relief valve when a steady stream of water (not air or air and water) is discharged from valve. Failure to do so could result in severe personal injury.

USE ONLY HAYWARD GENUINE REPLACEMENT PARTS

⚠ ATTENTION – NEVER OPERATE THE PUMP WITHOUT WATER. Water acts as a coolant and lubricant for the mechanical shaft seal. NEVER run pump dry. Running pump dry may damage seals, causing leakage, flooding, and voids warranty. Fill strainer housing with water before starting motor.

⚠ ATTENTION – Do NOT add chemicals to pool/spa system directly in front of pump suction. Adding undiluted chemicals may damage pump and voids warranty.

⚠ ATTENTION – Before removing strainer cover:

1. STOP PUMP before proceeding.
2. CLOSE VALVES in suction and outlet pipes.
3. RELEASE ALL PRESSURE from pump and piping system using filter manual air relief valve. See filter owner's manual for more details.
4. Remove strainer cover and fill strainer housing with water.
5. Clean and lubricate strainer cover gasket with "Jack's 327" if necessary.
6. Replace strainer cover on strainer housing; flip up the two hand knobs and turn clockwise to tighten cover.

NOTE - Tighten strainer cover hand knobs by hand only (no wrenches)

7. OPEN VALVES in suction and outlet pipes.

Turn on power and wait for pump to prime, which can take up to ten (10) minutes. Priming time will depend on vertical length of suction lift and horizontal length of suction pipe. If pump does NOT prime within 10 minutes, stop motor and determine cause. Be sure all suction and discharge valves are open when pump is running. See Troubleshooting Guide.

6.3. User Interface Summary

Figure 6.3-1

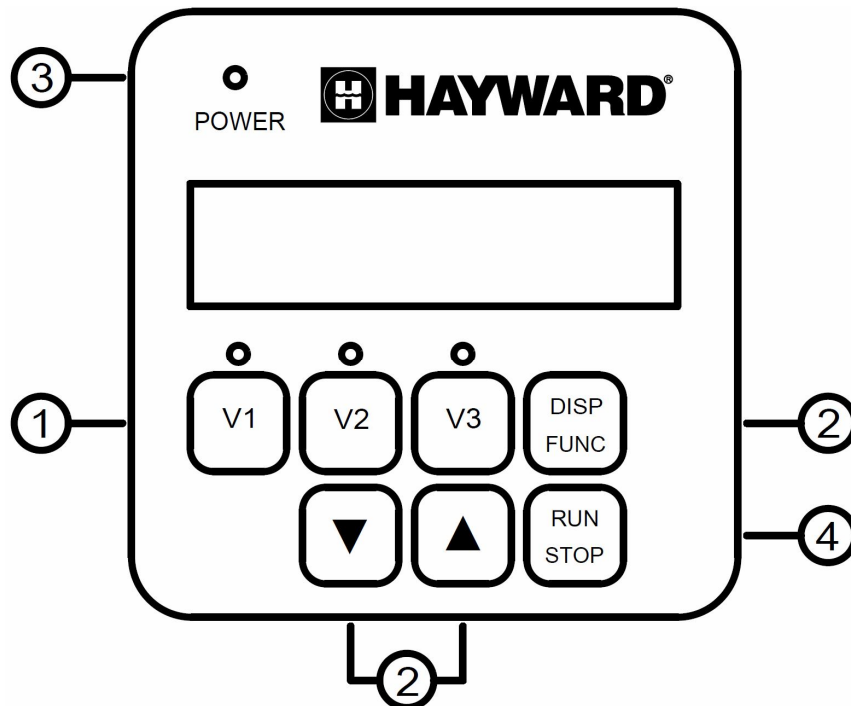

USE ONLY HAYWARD GENUINE REPLACEMENT PARTS



1. **Preset Speeds:** Buttons labeled V1 thru V3 can be used to run the pump at a predetermined speed for a certain length of time. Preset Speed settings can be quickly updated using the ▲ and ▼ arrow buttons to change the speed and then pressing both ▲ and ▼ arrow buttons simultaneously to save the new speed setting. When a speed is selected, the LED beside the button will illuminate to indicate operation.
 - a. **Start UP**
 - This pump is set to start in prime mode. When Priming has finished the pump will then switch to speed V3. The pump will run at this speed for its programmed time then switch to speed V1. The pump will then remain at speed V1 until power is cycled or another speed is selected.
 - b. **Default Speeds / TIME:**
 - V1: 1500 rpm
 - V2: 2400 rpm / 12 hours
 - V3: 3000 rpm / 12 hours
2. **Menu/navigation buttons:** The DISP/FUNC button will scroll through the home screen information when pressed. If the DISP/FUNC button is held for several seconds it will enter the controller into configuration mode. The ▲ and ▼ arrow buttons are used to change parameters within configuration mode.
3. **Power LED:** The POWER LED will remain illuminated while the unit has power unless the pump is experiencing an error. When the pump experiences an error the POWER LED will FLASH.
4. **Run/Stop:** This button is used to stop the pump to allow strainer basket cleaning, etc. When this button is pressed, the pump will remain stopped until the button is pressed a second time to resume normal operation.



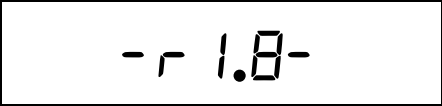

6.4. Menu Outline

1. **Configuration Menu** (see section 6.6 for basic product configuration)
 - a. Prime Mode Speed
 - b. V1 Speed
 - c. V2 Speed
 - d. V2 Timer
 - e. V3 Speed
 - f. V3 Timer

6.5. Initial startup

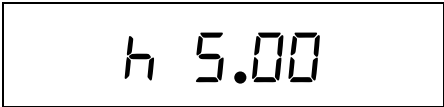
After plumbing and wiring are complete, the variable speed drive must be configured prior to use. When power is applied to the drive, the following informational screens are displayed.

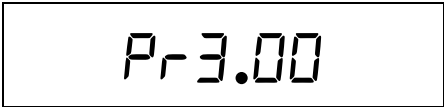
<u>Screen</u>	<u>Buttons</u> <u>Used</u>	<u>Comments</u>
		
		Pump software revision number will be displayed across the screen.
	DISP/FUNC	Displays the Motor RPM Cycles through to next screen

<u>Screen</u>	<u>Buttons Used</u>	<u>Comments</u>
	DISP/FUNC	Display current Time Remaining Cycles through to next screen Time Display: Hours . Minutes
	DISP/FUNC	Display Current power usage in Watts Cycles through to next screen
Note: When in prime mode the priming duration and RPM screens are as below to separate prime mode from normal operation.		
		When in Prime Mode the Prime mode Timer will display timer remaining for Prime Mode Time Display: Minutes . Seconds
	DISP/FUNC	The RPM display for Prime mode displays a rotating block to emphasize the pump is in prime mode.

Note: When Pump has finished Priming the pump will start speed V3 and display RPM.

Speeds can be selected at this time to temporarily run the pump, however, it is recommended that the drive configuration and timers be set according to individual installation site requirements (see Section 11 for more details). At this point, holding the DISP/FUNC button will enter into the Configuration Menu.

6.6. Configuration Menu

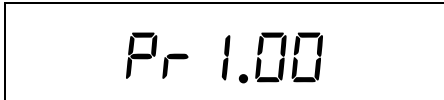
<u>Screen</u>	<u>Buttons Used</u>	<u>Comments</u>
	DISP/FUNC	Press & Hold button for several seconds to enter configuration mode
	▲▼ DISP/FUNC	Adjust the time of prime mode Move to the next selection

Note: The prime mode timer can be adjusted up to 4 minutes and down to 0.00 minutes. When adjusted to 0.00 minutes, prime mode will be disabled.

<u>Screen</u>	<u>Buttons Used</u>	<u>Comments</u>
1500	▲▼ DISP/FUNC	Adjust the motor rpm of V1 Move to the next selection
2400	▲▼ DISP/FUNC	Adjust the motor rpm of V2 Move to the next selection
h 12.00	▲▼ DISP/FUNC	Adjust the timer of V2 Move to the next selection
3000	▲▼ DISP/FUNC	Adjust the motor rpm of V3 Move to the next selection
h 12.00	▲▼ DISP/FUNC	Adjust the timer of V3 Exits the menu and saves all changed settings

Note: When entering into configuration mode, the LED for the speed being configured will FLASH. When completely exited from configuration mode the LED for the speed that was currently running will illuminate. If configuration mode is not completely exited after 2 minutes, the controller will save all settings excluding the current screen settings and exit configuration mode.



Note: The maximum allow speed for speeds V1 through V3 is 3,000 RPM. The minimum allowable speed for V1 through V3 is 600 RPM. The maximum allowable time for speeds V2 and V3 is 23 hours and 30 Minutes. The minimum allowable time for speed V2 and V3 is 30 Minutes.

6.7. Quick Speed Change

<u>Screen</u>	<u>Buttons Used</u>	<u>Comments</u>
1600	▲▼	Press ▲ or ▼ to change the current running speed
1600	▲ and ▼	Press ▲ and ▼ to save the new speed setting over the currently running speed

Note: When a quick speed change is performed the LED for the changed speed will FLASH. If the new speed setting is saved by PRESSING ▲ and ▼, the LED for that speed will illuminate solid. If the new speed setting is not saved, the pump will continue to run at the changed speed until the timer runs out for that speed or the speed is changed again. The LED for the changed speed will FLASH as long as a modified speed is running and has not been saved.

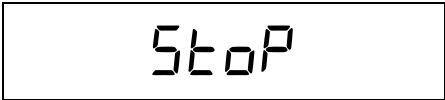
6.8. Stop/Resume

<u>Screen</u>	<u>Buttons Used</u>	<u>Comments</u>
	RUN STOP	
	RUN STOP	

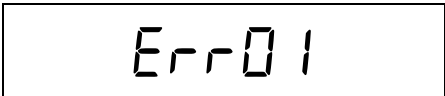

Note: When RUN / STOP is pressed at any time during normal operation, the above message will be displayed. The pump will stop within several seconds, and will remain stopped until RUN / STOP is pressed a second time, at which point the pump will resume normal operation.

6.9. Error Display

<u>Screen</u>	<u>Buttons Used</u>	<u>Comments</u>
		

Note: If an Internal Failure has been detected the pump will turn the drive off and display the error code corresponding to the error. As well, the Power LED will FLASH. A list of these error codes can be found in section 11.2. The cause of the internal error should be investigated and fixed before continuing to run the pump. When the cause of the error has been fixed, cycling power to the pump or pressing the RUN / STOP button will resume the pump.

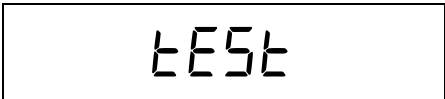
6.10. Service Mode

<u>Screen</u>	<u>Buttons Used</u>	<u>Comments</u>
	DISP/FUNC	Press and Hold DISP/FUNC and apply power to the pump
	▲▼ DISP/FUNC	Adjust the motor rpm of test mode Cycle through to the next screen

Note: When troubleshooting the pump it may be useful to run the pump without other program functions. This can be done in service mode. To enter service mode, remove power from the pump. Press and Hold DISP/FUNC and apply power to the pump. In this mode only the motor RPM's can be changed. To exit from service mode, cycle the power to the pump off and on.

6.11. Reset to Factory Settings

<u>Screen</u>	<u>Buttons Used</u>	<u>Comments</u>
	RUN STOP	Press and Hold RUN/STOP and apply power to the pump

Note: The pump may be set back to factory settings. To reset the pump to factory settings remove power from the pump. Press and Hold the RUN/STOP button and apply power to the pump. When the pump turns back on it will display the message above and reset all settings back to factory settings.

7. Maintenance

- Clean strainer basket regularly. Do NOT strike basket to clean. Inspect strainer cover gasket regularly and replace as necessary.
- Hayward pumps have self-lubricating motor bearings and shaft seals. No lubrication is necessary.
- Keep motor clean. Insure motor air vents are free from obstruction to avoid damage. Do NOT use water to hose off motor.
- Occasionally, shaft seals must be replaced, due to wear or damage. Replace with genuine Hayward seal assembly kit. See “Shaft Seal Change Instructions” in this manual.

8. Storage / Winterization



WARNING – Separation Hazard. Do not purge the system with compressed air. Purging the system with compressed air can cause components to explode, with risk of severe injury or death to anyone nearby. Use only a low pressure (below 5 PSI), high volume blower when air purging the pump, filter, or piping.

ATTENTION – Allowing the pump to freeze with water in it will void the warranty.

ATTENTION – Use ONLY propylene glycol as antifreeze in your pool/spa system. Propylene glycol is non-toxic and will not damage plastic system components; other anti-freezes are highly toxic and may damage plastic components in the system.

Drain all water from pump and piping when expecting freezing temperatures or when storing pump for a long time (see instructions below). Gravity drain system as far as possible.

Keep motor dry and covered during storage. To avoid condensation/corrosion problems, do NOT cover or wrap pump with plastic film or bags.

8.1. Storing Pump For Winterization



WARNING – To avoid dangerous or fatal electrical shock hazard, turn OFF power to motor before draining pump. Failure to disconnect power may result in serious personal injury or death.

1. Drain water level below all inlets to the pool.
2. Remove drain plugs and strainer cover from strainer housing.
3. Disconnect pump from mounting pad, wiring (after power has been turned OFF), and piping.
4. Once the pump is fully drained of water, re-install the strainer cover and drain plugs. Store pump in a dry area.

USE ONLY HAYWARD GENUINE REPLACEMENT PARTS

9. Shaft Seal Change Instructions

IMPORTANT SAFETY INSTRUCTIONS PLEASE READ AND FOLLOW ALL INSTRUCTIONS

When servicing electrical equipment, basic safety precautions should always be observed including the following. Failure to follow instructions may result in injury.

-  **WARNING** – To reduce risk of injury, do not permit children to use this product.
- Disconnect all electrical power service to pump before beginning shaft seal replacement.
- Only qualified personnel should attempt rotary seal replacement. Contact your local authorized Hayward Dealer or service center if you have any questions.

Exercise extreme care in handling both the rotating and the stationary sections of the two-part replacement seal. Foreign matter or improper handling will easily scratch the graphite and ceramic sealing surfaces.

9.1. Removing the Motor Assembly

1. Remove the four (4) 3/8" x 2" hex head bolts, which hold the motor assembly to the pump/strainer housing, using a 9/16" wrench or socket.
2. Slide the motor assembly out of the pump/strainer housing, exposing the diffuser. Pull the diffuser off of the seal plate to expose the impeller.

9.2. Removing the Impeller

3. To prevent the motor shaft from turning, secure using a 6mm hex wrench on the motor shaft through the fan shroud on the back of the pump.
4. Remove the impeller by rotating counterclockwise.

9.3. Removing the Ceramic Seat

5. Remove the spring seal assembly and seal plate from the motor by removing the four (4) 3/8" x 1" bolts that secure it to the motor, using a 9/16" wrench or socket.
6. Press the ceramic seat with rubber cup out of the seal plate. If tight, use a small screwdriver to tap seal out.
STOP - Clean all recesses & parts to be reassembled. Inspect gaskets & replace if necessary.

9.4. Seal Installation

7. Clean and lightly lubricate the motor shaft and seal recesses in the seal plate with a dilute solution of non-granulated liquid-type soap. Gently wipe the polished face of the ceramic seal with a soft cotton cloth. Lubricate the rubber cup on the ceramic seat and press it firmly into the recess of the seal plate, with the polished ceramic surface facing out.
8. Reassemble the motor to the seal plate using the four (4) 3/8" x 1" bolts. Torque the bolts to 100 in-lbs.
9. Gently wipe the black, polished surface of the spring seal assembly with a soft cotton cloth.
10. Press the spring seal assembly onto the motor shaft, with the black polished surface facing the ceramic seat.

9.5. Replacing the Impeller and Diffuser

11. Screw the impeller onto the motor shaft in a clockwise direction. Tighten snugly by holding motor shaft with wrench as noted in step #3.
12. Place the diffuser over the impeller and onto the seal plate, aligning the rib on the left side with the slot on the left of the diffuser.

USE ONLY HAYWARD GENUINE REPLACEMENT PARTS

9.6. Replacing the Motor Assembly

13. Slide the motor assembly, with the diffuser in place, into pump/strainer housing, being careful not to disturb the diffuser gasket.
14. Fasten assembly to pump/strainer housing using the four (4) 3/8" x 2" bolts. (Be sure housing gasket is in place, and lubricated. Replace if damaged). Tighten bolts alternately and evenly to 80 inch-pounds. Looking at the back of the pump, start with the top right, move diagonal to the bottom left, then up to the top left and last across to the bottom right.

10. Replacement Parts

10.1. Parts Diagram

Figure 10.1-1

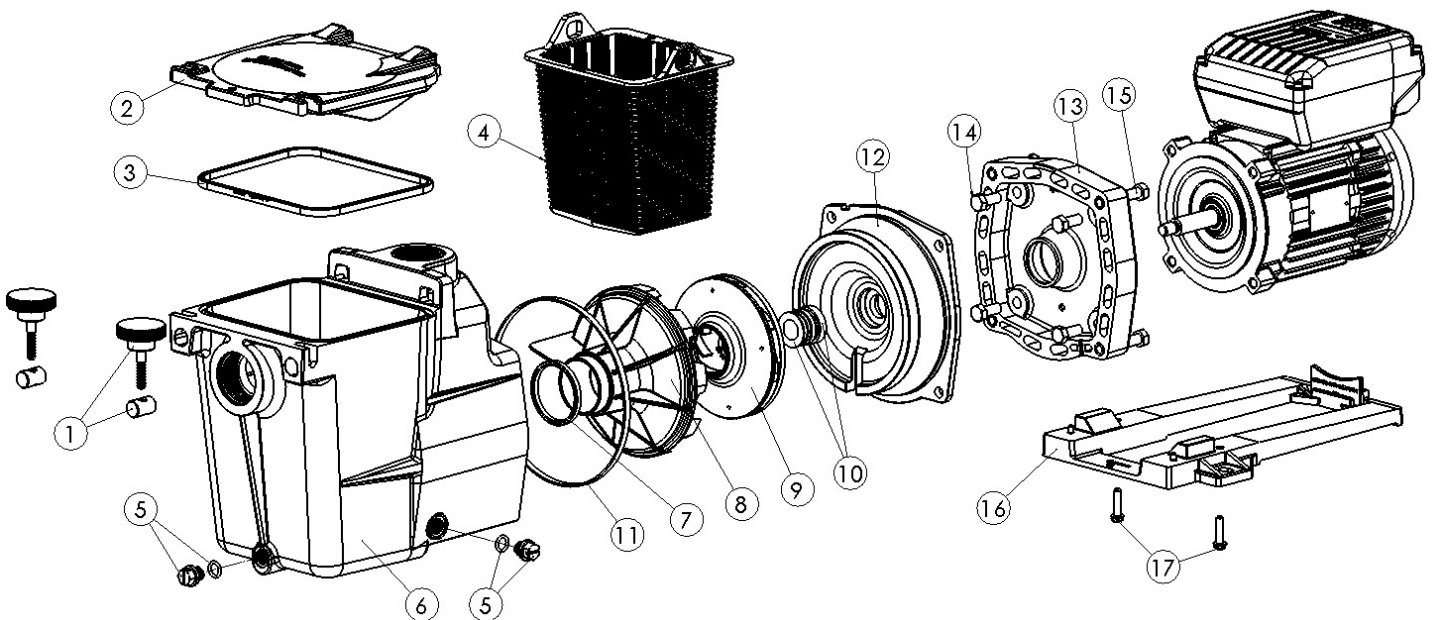

Ref. No.	Part No.	Description	Qty.
1	SPX1600PN	Swivel Nut & Hand Knob	2
2	SPX1600D	Strainer Cover	1
3	SPX1600S	Strainer Cover Gasket	1
4	SPX1600M	Basket	1
5	SPX1700FG	Drain Plug With Gasket	2
6	SPX1600AA	Pump/Strainer Housing With Gasket	1
7	SPX1600R	Diffuser Gasket	1
8	SPX1616B	Diffuser	1
9	SPX1621C	Impeller	1
10	SPX1600Z2	Shaft Seal Assembly	1
11	SPX1600T	Housing Gasket	1
12	SPX1611E5	Seal Plate	1

USE ONLY HAYWARD GENUINE REPLACEMENT PARTS

Ref. No.	Part No.	Description	Qty.
13	SPX1600F5	Motor Mounting Plate	1
14	SPX0125Z44	Motor Cap Screws (Set of 4)	1
15	SPX1600Z4	Housing Cap Screw	4
16	SPX2600G1	Mounting Foot (Includes Screws)	1
17	SPX1600Z52	Mounting Foot Screws (Set of 2)	1
-	SPXHKIT3	Quick Fix Kit (Includes #3, 7, 10, 11 & Jack's Lube)	1
	POWER END		
-	SPX2600Z1VSPE	Power End Assembly (Includes #7-14, motor and drive)	1

11. Troubleshooting

11.1. General Problems

- **Motor Will NOT Start:**
 1. Make sure the terminal board connections agree with the wiring diagram on the pump data plate label.
 2. Be sure the pump is wired for the available field supply voltage (230VAC).
 3. Check for and correct any improper or loose wiring connections; open switches or relays; tripped circuit breakers, or blown fuses.
 4. Manually check the rotation of the motor shaft for free movement and lack of obstruction. Correct if necessary.
- **Motor Shuts OFF:**
 1. Check for low voltage or power drop at the motor (frequently caused by undersized wiring). Contact a qualified professional to verify the electrical connections.
 2. If the pump experiences an intermittent power failure short enough to remain power to the controller but not the pump, the pump will stop the motor. To resume function to the pump PRESS the RUN / STOP key or cycle power long enough to turn the controller off.
- **Motor Hums, But Does NOT Start:**
 1. Impeller jammed with debris. Have a qualified repair professional open the pump and remove the debris.
- **Pump Won't Prime:**
 1. Empty pump/strainer housing. Make sure the pump/strainer housing is filled with water and the cover gasket is clean. Ensure the gasket is properly seated in the cover gasket groove. Ensure the gasket sealing surface is lubricated with "Jack's 327" and that the strainer cover is locked firmly in position. Lubricant will help to create a tighter seal.
 2. Loose connections on the suction side. Tighten the pipe/union connections.
NOTE - Any self-priming pump will not prime if there are suction air leaks. Leaks will result in bubbles emanating from the return fittings on the pool wall.
 3. Leaking O-ring or packing glands on valves. Tighten, repair, or replace the valves.
 4. Strainer basket or skimmer basket loaded with debris. Remove the strainer housing cover or the skimmer cover. Clean the basket, and refill the strainer housing with water. Tighten the cover.

USE ONLY HAYWARD GENUINE REPLACEMENT PARTS

5. Suction side clogged. Contact a qualified repair professional. You should have 5" - 6" of vacuum at the strainer cover (your pool dealer can confirm this with a vacuum gauge). You may be able to check by removing the skimmer basket and holding an object over the bottom port with the skimmer full and the pump running. If no suction is felt, check for line blockage.
 - a. If the pump develops a vacuum, check for a blocked suction line or a dirty strainer basket. An air leak in the suction piping may be the cause.
 - b. If the pump does not develop a vacuum and the pump has sufficient "priming water":
 - i. Re-check the strainer housing cover and all threaded connections for suction leaks. Check if all system hose clamps are tight.
 - ii. Check voltage to ensure that the motor is rotating at full rpm's.
 - iii. Open the housing cover and check for clogging or obstruction in suction. Check the impeller for debris.
 - iv. Remove and replace the shaft seal only if it is leaking

- **Low Flow – Generally:**

1. Clogged or restricted strainer or suction line. Contact a qualified repair professional.
2. Undersized pool piping. Correct the piping size.
3. Plugged or restricted discharge line of filter, valve partially closed (high gauge reading). Sand filters – backwash as per manufacturer's instructions; D.E. filters – backwash as per manufacturer's instructions; Cartridge filters – clean or replace the cartridge.
4. Air leak in suction (bubbles issuing from return fittings). Re-tighten the suction and discharge connections using Teflon tape. Inspect other plumbing connections, and tighten as required.
5. Plugged, restricted, or damaged impeller. Replace the impeller including a new seal assembly.

- **Noisy Pump:**

1. Air leak in suction piping, cavitations caused by restricted or undersized suction line or leak at any joint, low water level in pool, and unrestricted discharge return lines. Correct the suction condition or throttle return lines, if practical. Holding your hand over the return fitting will sometimes prove this, or by putting in a smaller eyeball fitting.
2. Vibration due to improper mounting, etc. Mount the pump on a level surface and secure the pump to the equipment pad.
3. Foreign matter in the pump housing. Loose stones/debris hitting the impeller could be the cause. Clean the pump housing.
4. Motor bearings noisy from normal wear, rust, overheating, or concentration of chemicals causing seal damage, which will allow chlorinated water to seep into bearings wiping out the grease causing bearing to whine. All seal leaks should be replaced at once.

11.2. Error Codes

In the case that an internal failure has been detected the pump will turn the motor off and display an error code listed below. If more than one error has been detected the screen will flash between the errors. The cause of the error should be investigated and resolved before continuing normal operation of the pump. When the issue has been resolved, press the RUN / STOP key to clear the error message.

<u>Screen</u>	<u>Buttons Used</u>	<u>Comments</u>
Err01		Error Number Detected

Code:	Indications:
01	Undervoltage on DC-Link
02	Overvoltage on DC-Link
10	Current Measurement Fails Permanently
20	Overload During Start Up Process
64	Short Circuit Failure
97	Multiple Errors at the Same Time, i.e. Undervoltage and Overload Error
98	Communication Failure From controller

12. Warranty

<p>HAYWARD® LIMITED WARRANTY</p> <p>To Buyer, as original purchaser of this equipment, Hayward Pool Products, 620 Division Street, Elizabeth, New Jersey, warrants its products free from defects in materials and workmanship for a period of ONE (1) year from the date of purchase.</p> <p>Parts which fail or become defective during the warranty period, except as a result of freezing, negligence, improper installation, use, or care, shall be repaired or replaced, at our option, without charge, within 90 days of the receipt of defective product, barring unforeseen delays.</p> <p>To obtain warranty replacements or repair, defective components or parts should be returned, transportation paid, to the place of purchase, or to the nearest authorized Hayward service center. For further Hayward dealer or service center information, contact Hayward customer service department. No returns may be made directly to the factory without the express written authorization of Hayward Pool Products.</p> <p>To original purchasers of this equipment, Hayward Pool Products warrants its products to be free from defects in materials and workmanship for a period of ONE (1) year from the date of purchase.</p> <p>Filters which become defective during the warranty period, except as a result of freezing, negligence, improper installation, use or care, shall be repaired or replaced, at our option, without charge.</p> <p>All other conditions and terms of the standard warranty apply.</p> <p>Hayward shall not be responsible for cartage, removal and/or reinstallation labor or any other such costs incurred in obtaining warranty replacements.</p> <p>The Hayward Pool Products warranty does not apply to components manufactured by others. For such products, the warranty established by the respective manufacturer will apply.</p> <p>Some states do not allow a limitation on how long an implied warranty lasts, or the exclusion or limitation of incidental or consequential damages, so the above limitation or exclusion may not apply to you.</p> <p>This warranty gives you specific legal rights, and you may also have other rights, which vary from state to state.</p> <p style="text-align: right;">Hayward Pool Products 620 Division Street Elizabeth, NJ 07207</p> <p>* Supersedes all previous publications.</p>

USE ONLY HAYWARD GENUINE REPLACEMENT PARTS

13. Product Registration

DATE OF INSTALLATION _____

INITIAL PRESSURE GAUGE READING AT 3,000 RPM (CLEAN FILTER) _____

PUMP MODEL _____

*Retain this Warranty Certificate in a safe and convenient location for your records



FCC Compliance Statement:

This device complies with part 15 of the FCC rules. Operation is subjected to the following two conditions: (1) This device may not cause harmful interference, and (2) this device must accept any interference received, including interference that may cause undesired operation.

This equipment has been tested and found to comply with limits for a Class B digital device, pursuant to Part 15 of the FCC rules. These limits are designed to provide reasonable protection against harmful interference in residential installations. This equipment generates, uses, and can radiate radio frequency energy, and if not installed and used in accordance with the instructions, may cause harmful interference to radio communications.

However, there is no guarantee that interference will not occur in a particular installation. If this equipment does cause interference to radio or television equipment reception, which can be determined by turning the equipment off and on, the user is encouraged to try to correct the interference by one of more of the following measures:

- Reorient or relocate the receiving antenna.
- Move the equipment away from the receiver.
- Plug the equipment into an outlet on a circuit different from that to which the receiver is connected.
- Consult the dealer or an experienced radio/television technician for additional suggestions.



DETACH HERE: Fill out bottom portion completely and mail within 10 days of purchase/installation or register online.

Super Pump® VS

Warranty Card Registration

Please Print Clearly:

First Name _____ Last Name _____

Street Address _____

City _____ State _____ Zip _____

Phone Number _____ Purchase Date _____

E-Mail Address _____

Serial Number																				
---------------	--	--	--	--	--	--	--	--	--	--	--	--	--	--	--	--	--	--	--	--

(10-17 digit number)

Model Number _____

Pool Capacity _____ (U.S. Gallons)

Please include me on all e-mail communications regarding Hayward Equipment or promotions.

Mail to: Hayward Pool Products, 620 Division Street, Elizabeth, NJ 07207

Attn: Warranty Dept

Or REGISTER YOUR WARRANTY ON-LINE AT WWW.HAYWARDPOOL.COM

Years Pool has been in service
 < 1 year 1-3 4-5 6-10 11-15 >15

Purchased from _____

Builder Retailer Pool Service Internet/Catalog

Company Name _____

Address _____

City _____ State _____ Zip _____

Phone _____

Type of Pool:
 Concrete/Gunite Vinyl Fiberglass
 Other _____

New Installation Replacement

Installation for:
 In Ground Spa



is a registered trademark and Super Pump VS is a trademark of Hayward Industries, Inc.

©2013 Hayward Industries. All rights reserved.