

Solid Cover Installation & Care Guide

Thank you for your purchase of a Tara Covers, Inc.'s quality Solid Pool Cover. With proper installation and care, your solid pool cover will provide protection for years to come. Every precaution has been taken to ensure that the cover has arrived at its destination without damage. Thoroughly inspect the condition of the containers and note any damage to the freight company at time of delivery.

READ ALL DIRECTIONS BEFORE STARTING

It is recommended that at least (2) individuals install a cover.

WARNING

AVOID DROWNING RISK

- DO NOT STAND OR WALK ON COVER EXCEPT IN AN EMERGENCY
- REMOVE COVER COMPLETELY BEFORE ENTRY OF BATHERS - ENTRAPMENT POSSIBLE
- REMOVE STANDING WATER - CHILD CAN DROWN ON TOP OF COVER
- NON-SECURED OR IMPROPERLY SECURED COVERS ARE A HAZARD
- FAILURE TO FOLLOW ALL INSTRUCTIONS MAY RESULT IN INJURY OR DROWNING
- INSPECT COVER PERIODICALLY FOR WEAR
- KEEP CHILDREN AWAY. CHILDREN OR OBJECTS CANNOT BE SEEN UNDER THE COVER
- KEEP COVER DRUM TIGHT TO AVOID UNSAFE STANDING WATER
- REPLACE WARNING LABELS IF THEY ARE DAMAGED OR BECOME ILLEGIBLE

If the warning labels are damaged or become illegible, copies can be obtained, free of charge, by calling 256-725-2500 or at www.taramfg.com.

WARNING

IMPORTANT INFORMATION SOLID POOL COVERS

You MUST use an automatic pool cover pump to drain water off the top of pool cover. Absence of a pump will cause a puddle of water on top of your pool cover, creating safety hazards and can damage cover. Place pump in the middle of the cover. An additional pump may be required depending on the size and shape of the pool.

INCLUDED HARDWARE

1. Brass Anchors
 - a. Screw Type Anchor
 - b. Wood Anchor
2. Compression Springs
Spring Covers
3. Anchor Tamping Tool
4. Installation Rod
5. Hex Key
6. Buckles

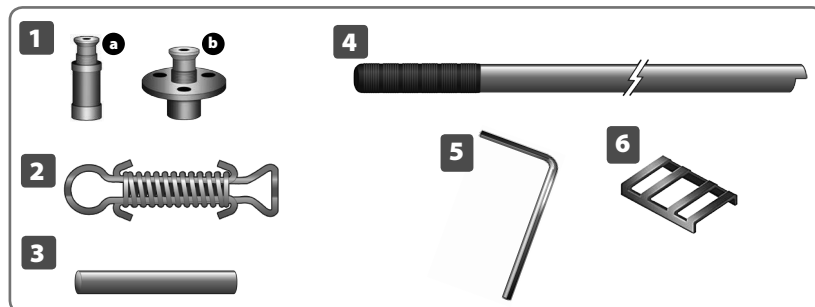

REQUIRED INSTALLATION TOOLS

- Heavy duty hammer drill
- 3/4" Concrete drill bit (Carbide or Diamond Tipped)
- Hammer
- Tape measure
- Chalk Line (Note: Red chalk can leave a permanent mark)
- Chalk (Note: Red chalk can leave a permanent mark)
- Extension Cords
- Buckets (5-Gallon) or Sand Bags
- Spray Silicone
- Wooden Block

Thank you for purchasing a Tara Cover's quality solid pool cover. With proper installation and care, your solid pool cover will provide years of worry-free protection. **Initial installation of pool covers should only be performed by qualified pool professionals.** Please review the following instructions carefully before installing this solid pool cover.

CONTENTS

Included Hardware	1
Preparation for Install	2
Lacing Cover Straps to Springs	2
Installing Rectangular Covers	2
Installing Free-form Covers	3
Installing Anchors	3
Fastening Springs to Anchors	3
Removing Springs from Anchors	3
Special Installations	3-4
Use & Care Instructions	4

PREPARATION FOR INSTALL

- Lift the cover out of the box and lay perpendicular to the long side of the pool. Unroll the cover so that it lays parallel to the pool. To prevent damage to the cover, do not drag it. The labels should face up and all of the strap reinforcements should be facing down.
- Remove all handrails, ladders, etc.
- Position 5 gallon buckets filled with water around the pool.
- Attach springs to all straps of the pool cover.
- If your pool has any areas with cut-outs or zero tolerance areas (e.g. walls, waterfalls or elevated spas), install these areas first. If there are several areas like this, start at most complicated.

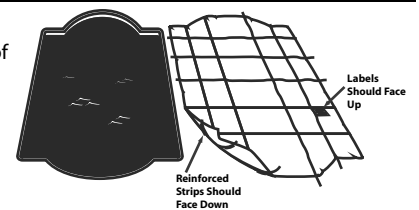

LACING SPRINGS TO STRAPS

Thread the strap through the spring and back through the buckle on the strap. The distance between the edge of the cover and the spring should be 10". The distance can be adjusted later if needed.

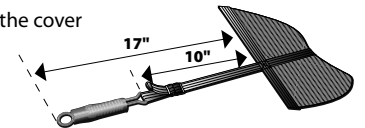

INSTALLING RECTANGULAR COVERS

Step 1

Measure your pool and your new cover. Adjust the cover for equal overlap. The side to side and end to end overlap may be different, but side should equal side and end should equal end. If there are any obstructions (e.g. rocks, rails, raised walls), position the cover so that cutouts fit around obstructions.

Note: The actual overlap may vary from 11" to 14" due to stretching or shrinkage during shipping.

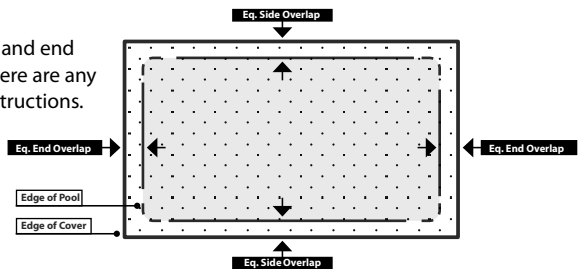

Step 2

Two corner anchors are required for each corner of the cover. Measure out 20", from each side and each end of the cover, 90° to the cover and install these anchors first. (For anchor installation detail, see the next page). Attach the springs to the anchors using the spring installation instructions, shown on the next page.

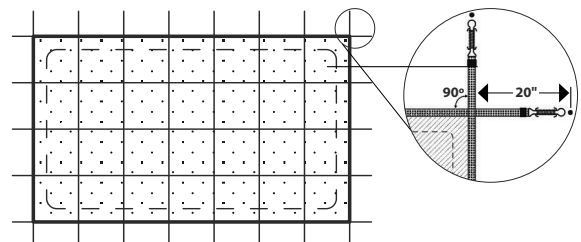

Step 3

Stretch strings between anchors on each side and each end. Locate and mark deep end anchors by extending the deep end cover straps until they intersect the deep end string line being sure to extend the straps at 90° to the cover. Repeat the process for the shallow end and then for each side. Once you have marked all of the anchor locations, install the anchors evenly and straight.

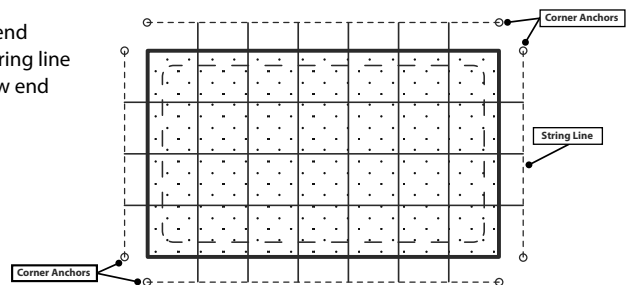

INSTALLING FREE-FORM COVERS

Step 1

Lay the cover across the pool and adjust it for equal overlap on all sides of the pool. Position the cover so that cutouts fit around any obstructions (e.g. rocks, rails, raised walls). Subtract the size of the pool from the size of the cover and divide by 2 to find the proper overlap distance. To hold the cover in place, put the 5 gallon buckets filled with water on the straps. (Do not place buckets on the cover material.)

Step 2

Using the drawing on the right as a guide, locate cover straps 1 through 8.

Step 3

Start with the center strap of the pools length (1). Pull the strap tight. Measure 20" from the edge of cover, and mark the location with chalk or tape. Drill the hole for the anchor and set it using the anchor installation instructions below. Attach the spring to the anchor using the instructions below. Go to the opposite end of the strap (3) and pull taut. Mark the anchor location. Drill and set the anchor. Now attach the spring to the anchor. Springs should be compressed about 60-75% (approx. $1\frac{3}{4}$ " apart) as shown in the diagram.

Step 4

Repeat this process for the 2 & 4 straps. Be sure to keep the straps pulled tight. Once these center straps across the length have been installed, do the same for the center straps across the width of the pool (5-8).

Step 5

After you have installed anchors 1 through 8 and attached straps 1 through 8 to those anchors, locate and install the remaining anchors in an alternating pattern. Work outwards from the middle of the sides fastening each spring as individual anchors are installed.

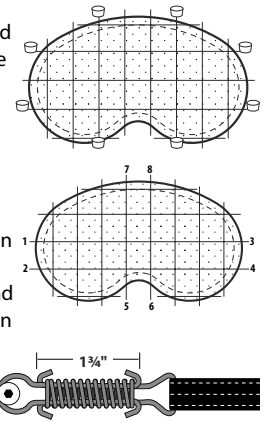

INSTALLING ANCHORS

Step 1

Drill $\frac{3}{4}$ " holes no more than the depth of the brass anchor ($1\frac{5}{8}$ "). Keep the drill straight and do not ream-out the diameter of the hole. If this does happen, apply adhesive to the brass anchor before setting into hole. Always clean the dust out of the hole before setting brass anchor.

Step 2

When your anchor hole is properly prepared, the anchor shell can be lightly tamped into position by inserting the tamping tool into the shell and tamping it into the deck with a mallet or hammer. Spray silicone lightly on the tamping tool prior to tamping to remove it easily. If the tamping tool gets jammed into the anchor, try gently tapping the tool on the sides to loosen it while pulling in an upward direction.

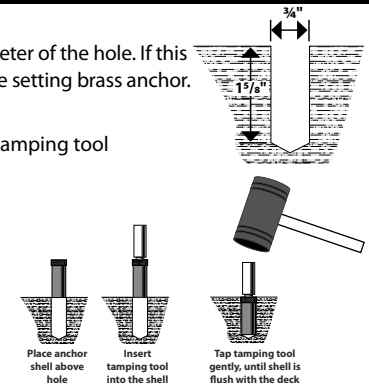

FASTENING SPRINGS TO ANCHORS

Step 1

Adjust the anchor insert to the up position with the hex key. Slide the installation rod through loop end of the cover spring and place the long tip end of the installation rod on the back side of the anchor (side farthest from the pool).

Step 2

Pull the rod's handle away from the pool. The spring will slide down the rod to the elongated tip. It is often helpful to push the spring down using your foot. The rod may also be lightly sprayed with a silicone lubricant to ease sliding. The spring will slide off the rod and onto the anchor head.

⚠ Cover should be drum-tight once all of the springs are fastened. If a cover is too loose, a child may be able to slip beneath. A loose cover may allow wind underneath. If the wind is able to whip the cover, the coping can wear on the fabric of the cover and damage it.

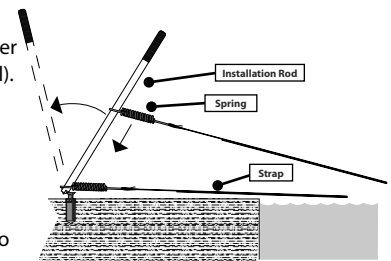

UNFASTENING ANCHORS FROM SPRINGS

Step 1

Insert installation rod over anchor ahead so that extended tip of rod fits into space inside looped end of spring (the pool side of the anchor).

Step 2

Rotate the rod a half turn so that the extended tip slides between the anchor and the end of the spring furthest away from the pool. Tilt the rod towards the pool. The spring will slide up the rod, releasing the spring from the anchor head. Once the tension has now been removed, the spring at the opposite end of this strap can now easily be removed from the anchor head by hand.

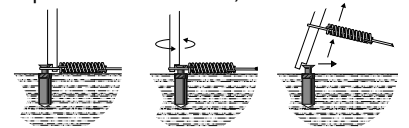

SPECIAL INSTALLATIONS

DIVE STAND

If you encounter an obstruction like a dive stand that is less than 30" from the edge of the pool, a center harness strap is one solution. Attach a D-ring to the cover strap. Feed a center harness strap through the D-ring and attach a spring to each end. Drill the anchor holes and anchor the springs as shown above. Other options: Request an offset strap at that location or hook a D-ring to an anchor.

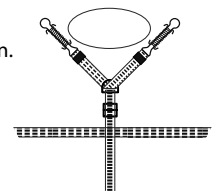

SPECIAL INSTALLATIONS (Cont.)

RAISED WALL OR STEP

If a pool has a low raised wall (less than 24" and in 6"-8" increments) the cover can go up and over the raised wall. If the raised area is higher than 24" Tara must approve the situation prior to the cover being made with an overlap. When the cover goes up and over a raised area triangular openings are created at the steps that go from the normal deck level to the raised area. A Step Kit is provided to close the exposed opening to the pool. The step riser kit can protect the pool from blowing leaves and debris as well as help to prevent entry into the covered pool area.

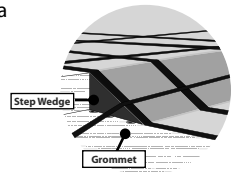

Step 1

Before tightening the pool cover anchors near the steps, tuck step wedges under the overlap edge of the cover, as needed. Place the wedges with the grommets on the ground.

Step 2

Drill $\frac{3}{4}$ " holes for anchors at the grommet locations. Then screw the anchor insert through the grommet to hold the riser in place. Repeat this procedure on the other side of the step wedge.

ZERO TOLERANCE / STRAIGHT WALL AREAS

Some pools have zero tolerance areas (e.g. walls, waterfalls or elevated spas) where no deck is available to secure an anchor. In this situation the cover can be attached directly to the wall using a cable kit. Note: These areas must be secured first before installing the rest of the cover

Step 1

Install a $\frac{3}{8}$ " drop-in anchor with $\frac{3}{8}$ " eyebolt on one end of the cable area.

Step 2

Install a $\frac{3}{8}$ " drop-in anchor on the other end and at 18" intervals in between. Screw cable anchor bolts in all of the drop-in anchors. Make sure the holes in the cable anchors run in the direction of the cable. Thread the cable through the anchor bolt holes and after the last anchor bolt make a loop in the cable. Use 2 cable clamps to make a tight secure loop.

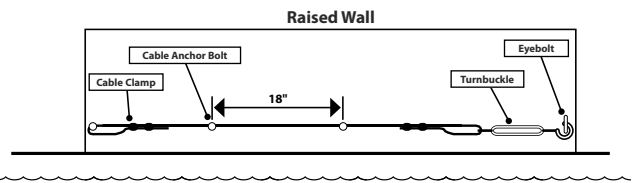

Step 3

At the other end of the cable, loop the cable through the eyebolt on the turnbuckle. Secure this end with a cable clamp.

Step 4

With the turnbuckle fully extended attach the hook end of the turnbuckle to the eyebolt anchored in the wall. Loosen the cable clamp holding the turnbuckle end and pull the cable tight. Tighten the cable clamp and add another making sure the cable is tight and secure. Then use the turnbuckle to tighten the cable as tight as possible.

Step 5

Attach the cover to the cable using the snaps sewn onto the underside of the cover.

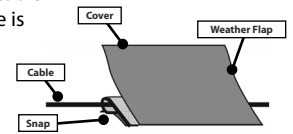

USE & CARE INSTRUCTIONS

Initial installation of pool covers should only be performed by qualified pool professionals. Improper installation can result in the warranty being voided.

MAINTAINING YOUR COVER

- Do not walk on cover except in an emergency.
- Clean and lube anchors every OPENING AND CLOSING.
- The water level in the pool must be between 15" and 18" below the cover at all times, or the warranty will be voided.
- Clean cover before storage.
- Inspect cover for damage.

STORING YOUR COVER

- Remove all leaves and debris from cover's surface.
- Spray cover with a hose and gently brush to loosen dirt.
- Check cover for damage. If your cover has damage have it repaired ASAP.
- Fold cover and store in the bag included with your order. *Fan folding is recommended.
- Hang bag off the ground to avoid mice and rodents.
- Keep cover away from chemicals and heat.

CLOSING YOUR POOL IN THE FALL

- The cover should be checked for damage that may have occurred during storage. Never raise the deck anchors prior to reinstalling, as damage may occur by dragging the cover over raised anchors. Keep anchors flush until the cover is positioned correctly over the

pool.

- When moving or handling the cover, never grab the paneled material, always move the cover by using the reinforced webbing and straps.

OPENING YOUR POOL

- The cover should be checked for damage that may have occurred during the winter season. Contact Tara for any repairs that may be needed. Lower deck anchors before moving the cover to prevent damage to the cover.
- When moving or handling the cover, never grab the paneled material, always move the cover by using the reinforced webbing and straps.

TIGHTENING STRAPS

In the event the springs are not compressed 50% for mesh covers and between 60% to 75% for solid covers, or the straps become loose, the straps should be tightened. Loose straps can cause premature cover wear. Remove the spring from the anchor with the installation rod. Using the strap and buckle, adjust the length of the strap by 2" increments and reinstall the spring on the anchor, using the installation tool until the spring is compressed 50% for mesh covers and 60% to 75% for solid covers and the straps are snug.

LEAVES COLLECTING ON COVER

Leaves collecting on the cover is a normal circumstance.

Simply allow them to dry and blow off. Should you find that the leaves tend to collect on the cover, ensure that the straps are taut across the pool to allow the leaves to blow away.

COVER CHAFE OR COPING WEAR:

Cover Chafe or coping wear is NOT a manufacturing defect and is NOT covered under the warranty. It can be caused by many things, including, but not limited to the following...

PROBLEM	SOLUTION
Loose cover	Adjust straps to tighten cover.
Rough coping	Smooth coping by removing any burrs or small pebbles. Pad coping with carpeting or some other non-abrasive substance. Tara Covers padding is also available through your dealer.
Windy area	Adjust straps to tighten cover Padding may also be needed.