

PoolBond PB-2008 Water Bonding Fitting
Follow these Important Safety Instructions

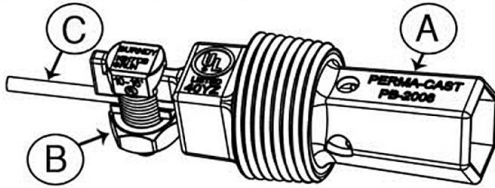

Part Number
PB-2008

Step 1 Components



- A. PoolBond Casting Part Number PB-2008 with 1" NPT Pipe Thread.
- B. Split Bolt Connector, UL rated for Direct Burial.
- C. Solid #8 Copper wire, not supplied.

Step 2 Fitting Orientation

- Install in Pool Plumbing using a Plumbing Tee.
- Always install the Poolbond Tee with the fitting in horizontal or vertically down orientation to avoid trapped air in pool plumbing.

Horizontal
All Installations

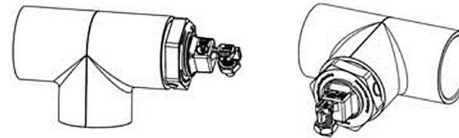

Vertical Down
Above Ground Pools

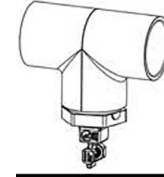

Step 3 Where to Install

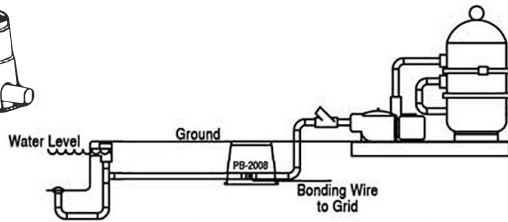

Installed near Pool Equipment — **OR** — Installed at Return Fitting

In-Ground Pools

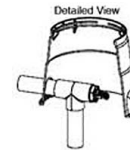
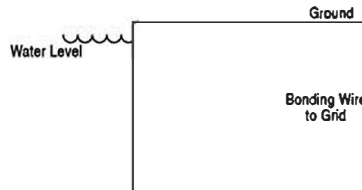

Above Ground Pools

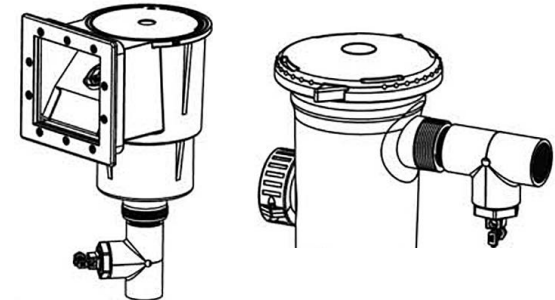

- Install on In-ground & Above Ground Pools, Spas, Tubs, & Fountains.
- **DO NOT** bury the PoolBond fitting, it should be accessible for periodic inspection. A sprinkler valve box provides good access.
- **IMPORTANT** - Install PoolBond fitting at least 3" below water level to assure the fitting is contained in the pool water even when equipment is shut down.

Step 4 Installing PoolBond

- First, install the male threaded fitting in the threaded tee (dry fit) until the fitting just starts to tighten on the threaded tee. Count the number of turns it takes. Document this number and disengage the two parts.
- Apply thread sealant. Use Plumber Pipe Dope or Teflon Paste, do not use Teflon Tape.
- Reassemble the two parts using the number of turns recorded in the first step and tighten two more turns. Do not overtighten to avoid damaging plastic pipe.

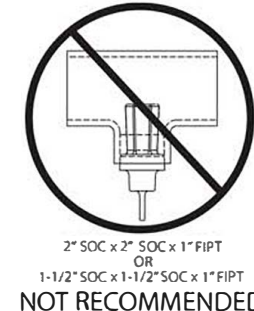
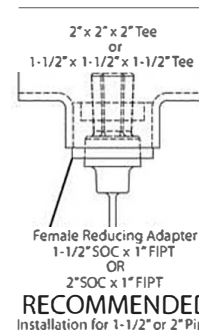

Perma-Cast LLC
1871 Aspen Circle
Pueblo, Colorado 81006

www.permacastonline.com

Revision 10/2020